

Panasonic AIR CONDITIONER

ACXF60-03890

CAUTION

R32 REFRIGERANT

This Air Conditioner contains and operates with refrigerant R32.

THIS PRODUCT MUST ONLY BE INSTALLED OR SERVICED BY QUALIFIED PERSONNEL.

Refer to National, State, Territory and local legislation, regulations, codes, installation & operation manuals, before the installation, maintenance and/or service of this product.

Required tools for Installation Works

1 Phillips screw driver	12 Megameter
2 Level gauge	14 Multimeter
3 Electric drill, hole core drill (ø70 mm)	18 Nmm (1.8 kgf*cm)
4 Hexagonal wrench (4 mm)	42 Nmm (4.3 kgf*cm)
5 Spanner	55 Nmm (5.6 kgf*cm)
6 Pipe cutter	65 Nmm (6.6 kgf*cm)
7 Reamer	100 Nmm (10.2 kgf*cm)
8 Knife	15 Vacuum pump
9 Gas leak detector	16 Gauge manifold
10 Measuring tape	
11 Thermometer	

Explanation of symbols displayed on the indoor unit or outdoor unit.

	WARNING	This symbol shows that this equipment uses a flammable refrigerant. If the refrigerant is leaked, together with an external ignition source, there is a possibility of ignition.
	CAUTION	This symbol shows that the Operation Manual should be read carefully.
	CAUTION	This symbol shows that a service personnel should be handling this equipment with reference to the Installation Manual.
	CAUTION	This symbol shows that there is information included in the Operation Manual and/or Installation Manual.

SAFETY PRECAUTIONS

- Read the following "SAFETY PRECAUTIONS" carefully before installation.
- Electrical work must be installed by a licensed electrician. Be sure to use the correct rating of the power plug and main circuit for the model to be installed.
- The caution items stated here must be followed because these important contents are related to safety. The meaning of each indication used is as below. Incorrect installation due to ignoring the instruction will cause harm or damage, and the seriousness is classified by the following indications.

	WARNING	This indication shows the possibility of causing death or serious injury.
	CAUTION	This indication shows the possibility of causing injury or damage to properties only.

The items to be followed are classified by the symbols:

	Symbol with white background denotes item that is PROHIBITED.
	Symbol with dark background denotes item that must be carried out.

- Carry out test running to confirm that no abnormally occurs after the installation. Then, explain to user the operation, care and maintenance as stated in instructions. Please remind the customer to keep the operating instructions for future reference.
- This appliance is not intended for accessibility by the general public.

WARNING

Do not use means to accelerate the defrosting process or to clean, other than those recommended by the manufacturer. Any unit method or using incompatible material may cause product damage, burst and serious injury.

Do not install outdoor unit near handrail of veranda. When installing air-conditioner unit on veranda of a high rise building, child may climb up to outdoor unit and cross over the handrail causing an accident.

Do not use unspecified cord, modified cord, joint cord or extension cord for power supply cord. Do not share the single outlet with other electrical appliances. Poor contact, poor insulation or over current will cause electrical shock or fire.

The appliance shall be stored in a well ventilated room with indoor floor area larger than A_{min} (m²) [refer Table A] and without any continuously operating ignition source. Keep away from open flames, any operating gas appliances or any operating electric heater. Else, it may explode and cause injury or death.

Do not tie up the power supply cord into a bundle by band. Abnormal temperature rise on power supply cord may happen.

Do not insert your fingers or other objects into the unit, high speed rotating fan may cause injury.

Do not sit or step on the unit, you may fall down accidentally.

The appliance shall be installed, and/or operated in a room with floor area larger than A_{min} (m²) [refer Table A] and keep away from ignition sources, such as heat/sparks/open flame or hazardous areas such as gas appliances, gas cooking, reticulated gas supply systems or electric cooking appliances, etc.

Keep plastic bag (packaging material) away from small children, it may cling to nose and mouth and prevent breathing.

When installing or relocating air conditioner, do not let any substance other than the specified refrigerant, eg. air etc mix into refrigeration cycle (piping). Mixing of air etc. will cause abnormal high pressure in refrigeration cycle and result in explosion, injury, etc.

Do not pierce or burn as the appliance is pressurized. Do not expose the appliance to heat, flame, sparks, or other sources of ignition. Else, it may explode and cause injury or death.

Do not add or replace refrigerant other than specified type. It may cause product damage, burst and injury etc.

Do not perform flare connection inside a building or dwelling or room, when joining the heat exchanger of indoor unit with interconnecting piping. Refrigerant connection inside a building or dwelling or room must be made by brazing or welding. Joint connection of indoor unit by flaring method can only be made at outdoor or at outside of a building or dwelling or room. Flare connection may cause gas leak and flammable atmosphere.

- For R32 model, use piping, flare nut and tools which is specified for R32 refrigerant. Using of existing (R22) piping, flare nut and tools may cause abnormally high pressure in the refrigerant cycle (piping), and possibly result in explosion and injury.
- Thickness for copper pipes used with R32 must be more than 0.8 mm. Never use copper pipes thinner than 0.8 mm.
- It is desirable that the amount of residual oil less than 40 mg/10 m.

- Engage authorized dealer or specialist for installation. If installation done by the user is incorrect, it will cause water leakage, electrical shock or fire.
- For refrigeration system work, install according to this installation instructions strictly. If installation is defective, it will cause water leakage, electrical shock or fire.
- Use the attached accessories parts and specified parts for installation. Otherwise, it will cause the set to fall, water leakage, fire or electrical shock.
- Install at a strong and firm location which is able to withstand weight of the set. If the strength is not enough or installation is not properly done, the set will drop and cause injury.
- For electrical work, follow the national regulation, legislation and this installation instructions. An independent circuit and single outlet must be used. If electrical circuit capacity is not enough or defect found in the electrical work, it will cause electrical shock or fire.
- Do not use joint cable for indoor / outdoor connection cable. Use the specified indoor/outdoor connection cable, refer to instruction ⑤ **CONNECT THE CABLE TO THE OUTDOOR UNIT** and connect tightly for indoor/outdoor connection. Clamp the cable so that no external force will have impact on the terminal. If connection or fixing is not perfect, it will cause heat up or fire at the connection.
- Wire routing must be properly arranged so that control board cover is fixed properly. If control board cover is not fixed perfectly, it will cause fire or electrical shock.
- This equipment is strongly recommended to be installed with Earth Leakage Circuit Breaker (ELCB) or Residual Current Device (RCD), with sensitivity of 30mA at 0.1 sec or less. Otherwise, it may cause electrical shock and fire in case of equipment breakdown or insulation breakdown.
- During installation, install the refrigerant piping properly before running the compressor. Operation of compressor without fixing refrigeration piping and valves at opened position will cause suck-in of air, abnormal high pressure in refrigeration cycle and result in explosion, injury etc.
- During pump down operation, stop the compressor before removing the refrigeration piping. Removal of refrigeration piping while compressor is operating and valves are opened will cause suck-in of air, abnormal high pressure in refrigeration cycle and result in explosion, injury etc.
- Tighten the flare nut with torque wrench according to specified method. If the flare nut is over-tightened, after a long period, the flare may break and cause refrigerant gas leakage.
- After completion of installation, confirm there is no leakage of refrigerant gas. It may generate toxic gas when the refrigerant contacts with fire.
- Ventilate if there is refrigerant gas leakage during operation. It may cause toxic gas when the refrigerant contacts with fire.
- Be aware that refrigerants may not contain an odour.
- This equipment must be properly earthed. Earth line must not be connected to gas pipe, water pipe, earth of lightning rod and telephone. Otherwise, it may cause electrical shock in case of equipment breakdown or insulation breakdown.

CAUTION

Do not install the unit in a place where leakage of flammable gas may occur. In case gas leaks and accumulates at surrounding of the unit, it may cause fire.

Prevent liquid or vapor from entering sumps or sewers since vapor is heavier than air and may form sulfocating atmospheres.

Do not release refrigerant during piping work for installation, re-installation and during repairing refrigeration parts. Take care of the liquid refrigerant, it may cause frostbite.

Do not install this appliance in a laundry room or other location where water may drip from the ceiling, etc.

Do not touch the sharp aluminium fin, sharp parts may cause injury.

Carry out drainage piping as mentioned in installation instructions. If drainage is not perfect, water may enter the room and damage the furniture.

Select an installation location which is easy for maintenance. Incorrect installation, service or repair of this air conditioner may increase the risk of rupture and this may result in loss damage or injury and/or property.

Power supply connection to the room air conditioner.
Use power supply cord 3 x 1.5 mm² (3/4 - 1.75HP), 3 x 2.5 mm² (2.0 - 2.5HP) type designation 60245 IEC 57 or heavier cord.
Connect the power supply cord of the air conditioner to the mains using one of the following method.
Power supply point should be in easily accessible place for power disconnection in case of emergency.
In some countries, permanent connection of this air conditioner to the power supply is prohibited.

- Power supply connection to the receptacle using power plug.
- Use an approved 15A/16A (3/4 - 1.75HP), 16A (2.0HP), 20A (2.5HP) power plug with earth pin for the connection to the socket.
- Power supply connection to a circuit breaker for the permanent connection.
Use an approved 16A (3/4 - 2.25HP), 20A (2.5HP) circuit breaker for the permanent connection. It must be a double pole switch with a minimum 3.0 mm contact gap.

Installation work.
It may need two people to carry out the installation work.

PRECAUTION FOR USING R32 REFRIGERANT

- The basic installation work procedures are the same as conventional refrigerant (R410A, R22) models. However, pay careful attention to the following points:
- ### WARNING

Since the working pressure is higher than that of refrigerant R22 models, some of the piping and installation and service tools are special. Especially, when replacing a refrigerant R22 model with a new refrigerant R32 model, always replace the conventional piping and flare nuts with the R32 and R410A piping and flare nuts on the outdoor unit side.

For R32 and R410A, the same flare nut on the outdoor unit side and pipe can be used.

Models that use refrigerant R32 and R410A have a different charging port thread diameter to prevent erroneous charging with refrigerant R22 and for safety. Therefore, check beforehand. The charging port thread diameter for R32 and R410A is 12.7 mm (1/2 inch).

Be more careful than R22 so that foreign matter (oil, water, etc.) does not enter the piping.

Also, when storing the piping, securely seal the opening by pinching, taping, etc. (Handling of R32 is similar to R410A.)

CAUTION

- Installation (Space)**
 - Must ensure the installation of pipe-work shall be kept to a minimum. Avoid use dented pipe and do not allow acute bending.
 - Must ensure that pipe-work shall be protected from physical damage.
 - Must comply with national gas regulations, state municipal rules and legislation. Notify relevant authorities in accordance with all applicable regulations.
 - Must ensure mechanical connections be accessible for maintenance purposes.
 - In cases that require mechanical ventilation, ventilation openings shall be kept clear of obstruction.
 - When disposal of the product, do follow to the precautions in #12 and comply with national regulations. Always contact to local municipal offices for proper handling.
- Servicing**
 - Service personnel**
 - Any qualified person who is involved with working on or breaking into a refrigerant circuit should hold a current valid certificate from an industry-accredited assessment authority, which authorizes their competence to handle refrigerants safely in accordance with an industry recognized assessment specification.
 - Servicing shall only be performed as recommended by the equipment manufacturer. Maintenance and repair requiring the assistance of other skilled personnel shall be carried out under the supervision of the person competent in the use of flammable refrigerants.
 - Servicing shall be performed only as recommended by the manufacturer.

- Work**
 - Prior to beginning work on systems containing flammable refrigerants, safety checks are necessary to ensure that the risk of ignition is minimised.
 - Or repeat to the refrigerating system, the precautions in #2-2 to #2-8 must be followed before conducting work on the system.
 - Work shall be undertaken under a controlled procedure so as to minimize the risk of a flammable gas or vapour being present while the work is being performed.
 - All maintenance staff and others working in the local area shall be instructed and supervised on the nature of work being carried out.
 - Avoid working in confined spaces.
 - Wear appropriate protective equipment, including respiratory protection, as conditions warrant.
 - Ensure that the conditions within the area have been made safe by limit of use of any flammable material. Keep all sources of ignition and hot metal surfaces away.

- Checking for presence of refrigerant**
 - The area shall be checked with an appropriate refrigerant detector prior to and during work, to ensure the technician is aware of potentially flammable atmospheres.
 - Ensure that the leak detection equipment being used is suitable for use with flammable refrigerants, i.e. non sparking, adequately sealed or intrinsically safe.
 - In case of leakage/spillage happened, immediately ventilate area and stay upwind and away from spill/release.
 - In case of leakage/spillage happened, do notify persons down wind of the leaking/spill, isolate immediate hazard area and keep unauthorized personnel out.

- Presence of fire extinguisher**
 - If any hot work is to be conducted on the refrigeration equipment or any associated parts, appropriate fire extinguishing equipment shall be available at hand.
 - Have a dry powder or CO₂ fire extinguisher adjacent to the charging area.

- No ignition sources**
 - No person carrying out work in relation to a refrigeration system which involves exposing any pipe work that contains or has contained flammable refrigerant shall use any sources of ignition such a manner that it may lead to the risk of fire or explosion. He/she must not be smoking when carrying out such work.
 - All possible ignition sources, including cigarette smoking, should be kept sufficiently far away from the site of installation, repairing, removing and disposal, during which flammable refrigerant can possibly be released to the surrounding space.
 - Prior to work taking place, the area around the equipment is to be surveyed to make sure that there are no flammable hazards or ignition risks.
 - No "Smoking" signs shall be displayed.

- Ventilated area**
 - Ensure that the area is in the open or that it is adequately ventilated before breaking into the system or conducting any hot work.
 - A degree of ventilation shall continue during the period that the work is carried out.
 - The ventilation should safely disperse any released refrigerant and preferably expel it externally into the atmosphere.

- Checks to the refrigeration equipment**
 - Where electrical components are being changed, they shall be fit for the purpose and to the correct specification.
 - At all times the manufacturer's maintenance and service guidelines shall be followed.
 - If in doubt consult the manufacturer's technical department for assistance.
 - The following checks shall be applied to installations using flammable refrigerants.
 - Charge size is in accordance with the room size within which the refrigerant containing parts are installed.
 - The ventilation machinery and outlets are operating adequately and are not obstructed.
 - If an indirect refrigerating circuit is being used, the secondary circuit shall be checked for the presence of refrigerant.
 - Marking to the equipment continues to be visible and legible. Markings and signs that are illegible shall be corrected.

- Checks to electrical devices**
 - Repair and maintenance to electrical components shall include initial safety checks and component inspection procedures.
 - Initial safety checks shall include but not limit to:-
 - That capacitors are discharged; this shall be done in a safe manner to avoid possibility of sparking.
 - That there is no live electrical components and wiring are exposed while charging, recovering or purging the system.
 - That there is no source of earth bonding.
 - At all times the manufacturer's maintenance and service guidelines shall be followed.
 - If in doubt consult the manufacturer's technical department for assistance.
 - If a fault exists that could compromise safety, then no electrical supply shall be connected to the circuit until it is satisfactorily dealt with.
 - If the fault cannot be corrected immediately but it is necessary to continue operation, an adequate temporary solution shall be used.
 - The owner of the equipment must be informed or reported so all parties are advised thereinafter.

- Repairs to sealed components**
 - During repairs to sealed components, all electrical supplies shall be disconnected from the equipment being worked upon prior to any removal of sealed covers, etc.
 - If it is absolutely necessary to have an electrical supply to equipment during servicing, then a permanently operating form of leak detection shall be located at the most critical point to warn of a potentially hazardous situation.
 - Particular attention shall be paid to the following to ensure that by working on electrical components, the casing is not altered in such a way that the level of protection is affected. This shall include damage to cables, excessive number of connections, materials not made to original specification, damage to seals, incorrect fitting of glands, etc.
 - Ensure that apparatus is mounted securely.
 - Ensure that seals or sealing materials have not degraded such that they no longer serve the purpose of preventing the ingress of flammable atmospheres.
 - Replacement parts shall be in accordance with the manufacturer's specifications.

NOTE: The use of silicon sealant may inhibit the effectiveness of some types of leak detection equipment. Intrinsically safe components do not have to be isolated prior to working on them.

- Repair to intrinsically safe components**
 - Do not apply any permanent inductive or capacitance loads to the circuit without ensuring that this will not exceed the permissible voltage and current permitted for the equipment in use.
 - Intrinsically safe components are the only types that can be worked on while live in the presence of a flammable atmosphere.
 - The test apparatus shall be at the correct rating.
 - Replace components only with parts specified by the manufacturer. Unspecified parts by manufacturer may result ignition of refrigerant in the atmosphere from a leak.
- Cabling**
 - Check that cabling will not be subject to wear, corrosion, excessive pressure, vibration, sharp edges or any other adverse environmental effects.
 - The check shall also take into account the effects of aging or continual vibration from sources such as compressors or fans.
- Detection of flammable refrigerants**
 - Under no circumstances shall potential sources of ignition be used in the searching or detection of refrigerant leaks.
 - A halide torch (or any other detector using a naked flame) shall not be used.
- Leak detection methods**
 - Electronic leak detectors shall be used to detect flammable refrigerants, but the sensitivity may not be adequate, or may need re-calibration. (Detection equipment shall be calibrated in a refrigerant-free area.)
 - Ensure that the detector is not a potential source of ignition and is suitable for the refrigerant used.
 - Leak detection equipment shall be set at a percentage of the LFL of the refrigerant and shall be calibrated to the refrigerant employed and the appropriate percentage of gas (25 % maximum) is confirmed.
 - Leak detection fluids are suitable for use with most refrigerants but the use of detergents containing chlorine shall be avoided as the chlorine may react with the refrigerant and corrode the copper pipe-work.
 - If a leak is suspected, all naked flames shall be removed/extinguished.
 - If a leakage of refrigerant is found which requires brazing, all of the refrigerant shall be recovered from the system, or isolated (by means of shut off valves) in a part of the system remote from the leak. Oxygen free nitrogen (OFN) shall then be purged through the system both before and during the brazing process.
- Removal and evacuation**
 - When breaking into the refrigerant circuit to make repairs – or for any other purpose – conventional procedures shall be used. However, it is important that best practice is followed since flammability is a consideration. The following procedure shall be adhered to:
 - remove refrigerant -> purge the circuit with inert gas -> evacuate -> purge again with inert gas -> open the circuit by cutting or brazing
 - The refrigerant charge shall be recovered into the correct recovery cylinders.
 - The system shall be "flushed" with OFN to render the unit safe.
 - This process may need to be repeated several times.
 - Compressed air or oxygen shall not be used for this task.
 - Flushing shall be achieved by breaking the vacuum in the system with OFN and continuing to fill until the working pressure is achieved, then venting to atmosphere, and finally pulling down to a vacuum.
 - This process shall be repeated until no refrigerant is within the system.
 - When the final OFN charge is used, the system shall be vented down to atmospheric pressure to enable work to take place.
 - This operation is absolutely vital if brazing operations on the pipe work are to take place.
 - Ensure that the outlet for the vacuum pump is not close to any ignition sources and there is ventilation available.

- Charging procedures**
 - In addition to conventional charging procedures, the following requirements shall be followed.
 - Ensure that contamination of different refrigerants does not occur when using charging equipment.
 - Hoses or lines shall be as short as possible to minimize the amount of refrigerant contained in them.
 - Cylinders shall be kept upright.
 - Ensure that the refrigeration system is earthed prior to charging the system with refrigerant.
 - Label the system when charging is complete (if not already).
 - Extreme care shall be taken not to over fill the refrigeration system.
 - Prior to recharging the system it shall be pressure tested with OFN (refer to #7).
 - The system shall be leak tested on completion of charging but prior to commissioning.
 - A follow up leak test shall be carried out prior to leaving the site.
 - Electrostatic charge may accumulate and create a hazardous condition when charging and discharging the refrigerant.
 - To avoid fire or explosion, dissipate static electricity during transfer by grounding and bonding containers and equipment before charging/discharging.
- Decommissioning**
 - Before carrying out this procedure, it is essential that the technician is completely familiar with the equipment and all its details.
 - It is recommended good practice that all refrigerants are recovered safely.
 - Prior to the task being carried out, an oil and refrigerant sample shall be taken in case analysis is required prior to re-use of reclaimed refrigerant.
 - It is essential that electrical power is available before the task is commenced.
 - Make sure that cylinder is situated on the scales before recovery takes place.
 - Start the recovery machine and operate in accordance with manufacturer's instructions.
 - Do not exceed the maximum working pressure of the cylinder, even temporarily.
 - When the cylinders have been filled correctly and the process completed, make sure that the cylinders and the equipment are removed from site promptly and all isolation valves on the equipment are closed off.
 - Recovered refrigerant shall not be charged into another refrigeration system unless it has been cleaned and checked.
 - mechanical handling equipment is available, if required, for handling refrigerant cylinders;
 - all personal protective equipment is available and being used correctly;
 - the recovery process is supervised at all times by a competent person;
 - recovery equipment and cylinders conform to the appropriate standards.
 - Pump down refrigerant system, if possible.
 - If a vacuum is not possible, make a manifold so that refrigerant can be removed from various parts of the system.
 - Electrostatic charge may accumulate and create a hazardous condition when charging or discharging the refrigerant.
 - To avoid fire or explosion, dissipate static electricity during transfer by grounding and bonding containers and equipment before charging/discharging.

- Labeling**
 - Equipment shall be labelled stating that it has been de-commissioned and emptied of refrigerant.
 - The label shall be dated and signed.
 - Ensure that there are labels on the equipment stating the equipment contains flammable refrigerant.
- Recovery**
 - When removing refrigerant from a system, either for servicing or decommissioning, it is recommended good practice that all refrigerants are removed safely.
 - When transferring refrigerant into cylinders, ensure that only appropriate refrigerant recovery cylinders are employed.
 - Ensure that the correct number of cylinders for holding the total system charge are available.
 - All cylinders to be used are designated for the recovered refrigerant and labelled for that refrigerant (i.e. special cylinders for the recovery of refrigerant).
 - Cylinders shall be complete with pressure relief valve and associated shut-off valves in good working order.
 - Recovery cylinders are evacuated and, if possible, cooled before recovery occurs.
 - The recovery equipment shall be in good working order with a set of instructions concerning the equipment that is at hand and shall be suitable for the recovery of flammable refrigerants.

- In addition, a set of calibrated weighing scales shall be available and in good working order.
- Hoses shall be complete with leak-free disconnect couplings and in good condition.
- Before using the recovery machine, check that it is in satisfactory working order, has been properly maintained and that any associated electrical components are sealed to prevent ignition in the event of a refrigerant release. Consult manufacturer if in doubt.
- The recovered refrigerant shall be returned to the refrigerant supplier in the correct recovery cylinder, and the relevant Waste Transfer Note arranged.
- Do not mix refrigerants in recovery units and especially not in cylinders.
- If compressors or compressor oils are to be removed, ensure that they have been evacuated to an acceptable level to make certain that flammable refrigerant does not remain within the lubricant.
- The evacuation process shall be carried out prior to returning the compressor to the suppliers.
- Only electric heating to the compressor body shall be employed to accelerate this process.
- When oil is drained from a system, it shall be carried out safely.

Attached accessories

No.	Accessories part	Qty.
1	Drain elbow	1

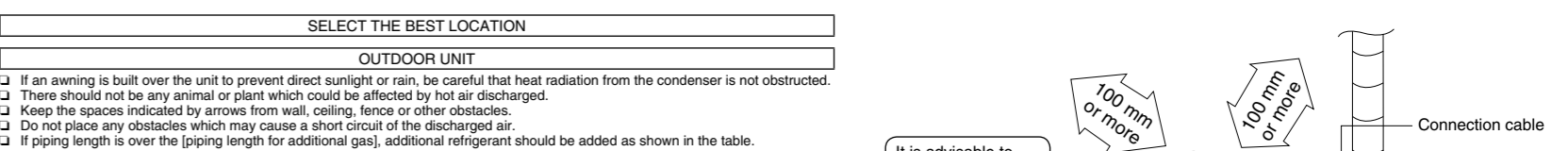

Table A

Model	Capacity W (HP)	Piping size		Std. Length (m)	Max. Elevation (m)	Min. Piping Length (m)	Max. Piping Length (m)	Additional Refrigerant (g/m)	Piping Length add. gas (m)	Indoor Area (m ²)
		Gas	Liquid							
Z20***, XZ20***	3/4HP	9.52mm (3/8")	6.35mm (1/4")	5	15	3	15	10	7.5	0.66
Z25***, XZ25***	1.0HP	9.52mm (3/8")	6.35mm (1/4")	5	15	3	15	10	7.5	0.82
Z35***, XZ35***	1.5HP	9.52mm (3/8")	6.35mm (1/4")	5	15	3	15	10	7.5	0.93
Z42***	1.75HP	12.7mm (1/2")	6.35mm (1/4")	5	15	3	15	10	7.5	0.85
Z50***, XZ50***	2.0HP	12.7mm (1/2")	6.35mm (1/4")	5	15	3	20	15	7.5	1.61
Z71***	2.5HP	15.88mm (5/8")	6.35mm (1/4")	5	20	3	30	25	10	3.33

Example: For Z25***
If the unit is installed at 10 m distance, the quantity of additional refrigerant should be 25 g - (10-7.5) x 10 g/1m = 25 g.

$$A_{min} = (M / (2.5 \times (LFL)^{0.50} \times h_o))^{2.0}$$

A_{min} = Required minimum room area, in m²
 M = Refrigerant charge amount in appliance, in kg
 LFL = Lower flammable limit (0.306 kg/m³)
 h_o = Installation height of the appliance (1.8 m for wall mounted)

Installation parts you should purchase (X)

- Connection cable
- Liquid side piping (X)
- Gas side piping (X)
- Additional drain hose (X)

OUTDOOR UNIT

1 SELECT THE BEST LOCATION (Refer to "Select the best location" section)

2 INSTALL THE OUTDOOR UNIT

- After selecting the best location, start installation to Indoor/Outdoor Unit Installation Diagram.
- Fix the unit on concrete or rigid frame firmly and horizontally by bolt nut (ø10 mm).
- When installing at roof, please consider strong wind and earthquake. Please fasten the installation stand firmly with bolt, screws or nails.

Model	A	B	C	D
Z20***, XZ20***	570 mm	105 mm	18.5 mm	320 mm
Z25***, XZ25***	540 mm	160 mm	18.5 mm	330 mm
Z42***	613 mm	131 mm	16 mm	360.5 mm
Z50***, XZ50***				
Z71***				

3 CONNECT THE PIPING TO THE OUTDOOR UNIT

CONNECTING THE PIPING TO INDOOR

For connection joint location at outside building
Please make flare after inserting flare nut (locate at joint portion of tube assembly) onto the copper pipe. (In case of using long piping)
Connect the piping.
Align the center of piping and sufficiently tighten the flare nut with fingers.
Further tighten the flare nut with torque wrench in specified torque as stated in the table.

CONNECTING THE PIPING TO OUTDOOR

Decide piping length and then cut by using pipe cutter. Remove burrs from cut edge. Make flare after inserting the flare nut (locate at valve) onto the copper pipe. Align center of piping to valve and then tighten with torque wrench to the specified torque as stated in the table.

Piping size	Torque
6.35 mm (1/4")	18 Nmm (1.8 kgf*cm)
9.52 mm (3/8")	42 Nmm (4.3 kgf*cm)
12.7 mm (1/2")	55 Nmm (5.6 kgf*cm)
15.88 mm (5/8")	65 Nmm (6.6 kgf*cm)
19.05 mm (3/4")	100 Nmm (10.2 kgf*cm)

4 EVACUATION OF THE EQUIPMENT

AIR PURGING METHOD IS PROHIBITED FOR R32 SYSTEM

WHEN INSTALLING AN AIR CONDITIONER, BE SURE TO EVACUATE THE AIR INSIDE THE INDOOR UNIT AND PIPES IN THE following procedure.

- Do not purge the air with refrigerants but use a vacuum pump to vacuum the installation.
- There is no extra refrigerant in the outdoor unit for air purging.

- Connect a charging hose with a push pin to the Low side of a charging set and the service port of the 3-way valve.
- Connect the center hose of the charging set to a vacuum pump.
- Turn on the power switch of the vacuum pump and make sure that the needle in the gauge moves from 0 cmHg (0 MPa) to -76 cmHg (-0.1 MPa). Then evacuate the air approximately ten minutes.
- Close the Low side valve of the charging set and turn off the vacuum pump. Make sure that the needle in the gauge does not move after approximately five minutes.

PROCEDURE IN ORDER TO AVOID REFRIGERANT GAS LEAKAGE.

- Disconnect the charging hose from the vacuum pump and from the service port of the 3-way valve.
- Tighten the service port caps of the 3-way valve with a torque wrench.
- Remove the valve caps of both of the 2-way valve and 3-way valve. Position both of the valves to "OPEN" using a hexagonal wrench (4 mm).
- Mount valve caps

Required tools for Installation Works

1 Phillips screw driver	7 Reamer	13 Multimeter	100 N•m (10.2 kgf•m)
2 Level gauge	8 Knife	14 Torque wrench	15 Vacuum pump
3 Electric drill, hole core drill (φ70 mm)	9 Gas leak detector	18 N•m (1.8 kgf•m)	16 Gauge manifold
4 Hexagonal wrench (4 mm)	10 Measuring tape	42 N•m (4.3 kgf•m)	
5 Spanner	11 Thermometer	55 N•m (5.6 kgf•m)	
6 Pipe cutter	12 Megameter	65 N•m (6.6 kgf•m)	

SAFETY PRECAUTIONS

- Read the following "SAFETY PRECAUTIONS" carefully before installation.
- This installation manual must be used together with another installation manual incorporated in applicable outdoor unit as complete full set of instructions.
- Confirm the type of gas used before installation.
- Electrical work must be installed by a licensed electrician. Be sure to use the correct rating of the power plug and main circuit for the model to be installed.
- The caution items stated here must be followed because these important contents are related to safety. The meaning of each indication used is as below. Incorrect installation due to ignoring of the instruction will cause harm or damage, and the seriousness is classified by the following indicators.

WARNING	This indication shows the possibility of causing death or serious injury.
CAUTION	This indication shows the possibility of causing injury or damage to properties only.

- The items to be followed are classified by the symbols:
- Symbol with white background denotes item that is PROHIBITED.
- Symbol with dark background denotes item that must be carried out.

- Carry out test running to confirm that no abnormality occurs after the installation. Then, explain to user the operation, care and maintenance as stated in instructions. Please remind the customer to keep the operating instructions for future reference.
- This appliance is not intended for accessibility by the general public.

WARNING

- Do not use means to accelerate the defrosting process or to clean, other than those recommended by the manufacturer. Any unit method or using incompatible material may cause product damage, burst and serious injury.
- Do not install outdoor unit near handrail of veranda. When installing air-conditioner unit on veranda of a high rise building, child may climb up to outdoor unit and cross over the handrail causing an accident.
- Do not use unspecified cord, modified cord, joint cord or extension cord for power supply cord. Do not share the single outlet with other electrical appliances. Poor contact, poor insulation or over current will cause electrical shock or fire.
- Do not tie up the power supply cord into a bundle by band. Abnormal temperature rise on power supply cord may happen.
- Do not insert your fingers or other objects into the unit, high speed rotating fan may cause injury.
- Do not sit or step on the unit, you may fall down accidentally.
- Keep plastic bag (packaging material) away from small children, it may cling to nose and mouth and prevent breathing.
- When installing or relocating air conditioner, do not let any substance other than the specified refrigerant, eg. air etc mix into refrigeration cycle (piping). Mixing of air etc. will cause abnormal high pressure in refrigeration cycle and result in explosion, injury etc.
- Do not pierce or burn as the appliance is pressurized. Do not expose the appliance to heat, flame, sparks, or other sources of ignition. Else, it may explode and cause injury or death.
- Do not add or replace refrigerant other than specified type. It may cause product damage, burst and injury etc.

- For R410A/R32 model, use piping, flare nut and tools which is specified for R32 refrigerant. Using of existing (R22) piping, flare nut and tools may cause abnormally high pressure in the refrigerant cycle (piping), and possibly result in explosion and injury.
- Thickness for copper pipes used with R32 must be more than 0.8 mm. Never use copper pipes thinner than 0.8 mm.
- It is desirable that the amount of residual oil less than 40 mg/10 m.

- Engage authorized dealer or specialist for installation. If installation done by the user is incorrect, it will cause water leakage, electrical shock or fire.
- For refrigeration system work, install according to this installation instructions strictly. If installation is defective, it will cause water leakage, electrical shock or fire.

- Use the attached accessories parts and specified parts for installation. Otherwise, it will cause the set to fall, water leakage, fire or electrical shock.
- Install at a strong and firm location which is able to withstand weight of the set. If the strength is not enough or installation is not properly done, the set will drop and cause injury.

- For electrical work, follow the national regulation, legislation and this installation instructions. An independent circuit and single outlet must be used. If electrical circuit capacity is not enough or defect found in the electrical work, it will cause electrical shock or fire.
- Do not use joint cable for indoor / outdoor connection cable. Use the specified indoor/outdoor connection cable. Refer to instruction ⑤ **CONNECT THE CABLE TO THE INDOOR UNIT** and connect tightly for indoor/outdoor connection. Clamp the cable so that no external force will have impact on the terminal. It will cause heat up or fire at the connection.

- Wire routing must be properly arranged so that control board cover is fixed properly. If control board cover is not fixed properly, it will cause fire or electrical shock.
- This equipment is strongly recommended to be installed with Earth Leakage Circuit Breaker (ELCB) or Residual Current Device (RCD), with sensitivity of 30mA at 0.1 sec or less. Otherwise, it may cause electrical shock and fire in case of equipment breakdown or insulation breakdown.

- During installation, install the refrigerant piping properly before running the compressor. Operation of compressor without fixing refrigeration piping and valves at opened position will cause suck-in of air, abnormal high pressure in refrigeration cycle and result in explosion, injury etc.
- During pump down operation, stop the compressor before removing the refrigeration piping. Removal of refrigeration piping while compressor is operating and valves are opened will cause suck-in of air, abnormal high pressure in refrigeration cycle and result in explosion, injury etc.

- Tighten the flare nut with torque wrench according to specified method. If the flare nut is over-tightened, after a long period, the flare may break and cause refrigerant gas leakage.
- After completion of installation, confirm there is no leakage of refrigerant gas. It may generate toxic gas when the refrigerant contacts with fire.

- Ventilate if there is refrigerant gas leakage during operation. It may cause toxic gas when the refrigerant contacts with fire.
- Be aware that refrigerants may not contain an odour.

- This equipment must be properly earthed. Earth line must not be connected to gas pipe, water pipe, earth of lightning rod and telephone. Otherwise, it may cause electrical shock in case of equipment breakdown or insulation breakdown.

CAUTION

- Do not install the unit in a place where leakage of flammable gas may occur. In case gas leaks and accumulates at surrounding of the unit, it may cause fire.
- Prevent liquid or vapor from entering stops or sewers since vapor is heavier than air and may form suffocating atmospheres.

- Do not release refrigerant during piping work for installation, re-installation and during repairing refrigeration parts. Take care of the liquid refrigerant, it may cause frostbite.
- Do not install this appliance in a laundry room or other location where water may drip from the ceiling, etc.

- Do not touch the sharp aluminium fin, sharp parts may cause injury.
- Carry out drainage piping as mentioned in installation instructions. If drainage is not perfect, water may enter the room and damage the furniture.

- Select an installation location which is easy for maintenance.
- Incorrect installation, service or repair of this air conditioner may increase the risk of rupture and this may result in loss damage or injury and/or property.

- Power supply connection to the room air conditioner. Use power supply cord 3 x 1.5 mm² (3/4-1.75HP), 3 x 2.5 mm² (2.0-2.5HP) type designation 60245 IEC 57 or heavier cord. Connect the power supply cord of the air conditioner to the mains using one of the following method. Power supply point should be in easily accessible place for power disconnection in case of emergency. In some countries, permanent connection of this air conditioner to the power supply is prohibited.

- Power supply connection to the receptacle using power plug. Use an approved 15/16A (3/4-1.75HP), 16A (2.0HP), 20A (2.5HP) power plug with earth pin for the connection to the socket.
- Power supply connection to a circuit breaker for the permanent connection. Use an approved 16A (3/4-2.0HP), 20A (2.5HP) circuit breaker for the permanent connection. It must be a double pole switch with a minimum 3.0 mm contact gap.

- Installation work. It may need two people to carry out the installation work.

PRECAUTION FOR USING R32 REFRIGERANT

- The basic installation work procedures are the same as conventional refrigerant (R410A, R22) models. However, pay careful attention to the following points:
- Do not perform flare connection inside a building or dwelling or room, when joining the heat exchanger of indoor unit with interconnecting piping. Refrigerant connection inside a building or dwelling or room must be made by brazing or welding. Joint connection of indoor unit by flaring method can only be made at outdoor or at outside of a building or dwelling or room. Flare connection may cause gas leak and flammable atmosphere.

- The appliance shall be stored, installed and operated in a well ventilated room with indoor floor area larger than A_{min} (m²) (refer Table A) and without any continuously operating ignition source. Keep away from open flames, any operating gas appliances or any operating electric heater. Else, it may explode and cause injury or death.
- Refer to "PRECAUTION FOR USING R32 REFRIGERANT" in outdoor unit installation manual for other precautions that need to pay attention to.

Attached accessories

No.	Accessories part	Qty.	No.	Accessories part	Qty.
1	Installation plate	1	3	Remote control	1
2	Installation plate fixing screw	4	4	Battery	2
			5	Remote control holder	1
			6	Remote control holder fixing screw	2

Applicable piping kit	Piping size
CZ-3FS, 7BP	Gas 9.52 mm (3/8") Liquid 6.35 mm (1/4")
CZ-4FS, 7, 10BP	12.7 mm (1/2") 6.35 mm (1/4")
CZ-5FS, 7, 10BP	15.88 mm (5/8") 6.35 mm (1/4")

- Pipe Size Reducer (CZ-MA1P, CZ-MA3P) and Expander (CZ-MA2P) for Outdoor Multi Connection CS-Z42***, CS-Z50***, CS-X250***, CS-Z71***
- Please refer to "CONNECT THE PIPING" section

SELECT THE BEST LOCATION

INDOOR UNIT

- Do not install the unit in excessive oil fume areas such as kitchen, workshop and etc.
- There should not be any heat source or steam near the unit.
- There should not be any obstacles blocking the air circulation.
- A place where air circulation in the room is good.
- A place where drainage can be easily done.
- A place where noise prevention is taken into consideration.
- Do not install the unit near the door way.
- Ensure the spaces indicated by arrows from the wall, ceiling, fence or other obstacles.

Model	Capacity	Indoor A _{min} (m ²)
Z220***, X220***	3.4/4HP	0.66
Z235***, X235***	1.0HP	0.62
Z250***, X250***	1.5HP	0.63
Z42***, X42***	1.7/3HP	0.85
Z271***, X271***	2.0HP	1.01
Z271***, X271***	2.5HP	3.53

- A_{min} = (M / (2.5 x (LFL)^{1/3} x h_i))²
- M = Required minimum room area, in m²
- LFL = Refrigerant charge amount in appliance, in kg
- LFL = Lower flammable limit (0.306 kg/m³)
- h_i = Installation height of the appliance (1.8 m for wall mounted)

- It is advisable to avoid more than 2 blockage directions. For better ventilation & multiple-outdoor installation, please consult authorized dealer/specialist.
- This illustration is for explanation purposes only. The indoor unit will actually face a different way.

Indoor/Outdoor Unit Installation Diagram

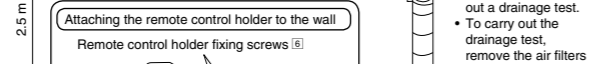
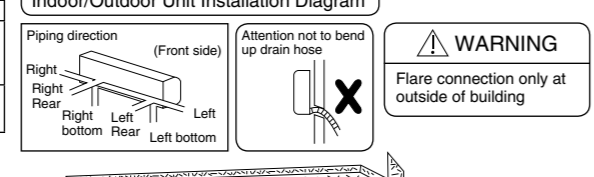

INDOOR UNIT

1 SELECT THE BEST LOCATION (Refer to "Select the best location" section)

2 HOW TO FIX INSTALLATION PLATE

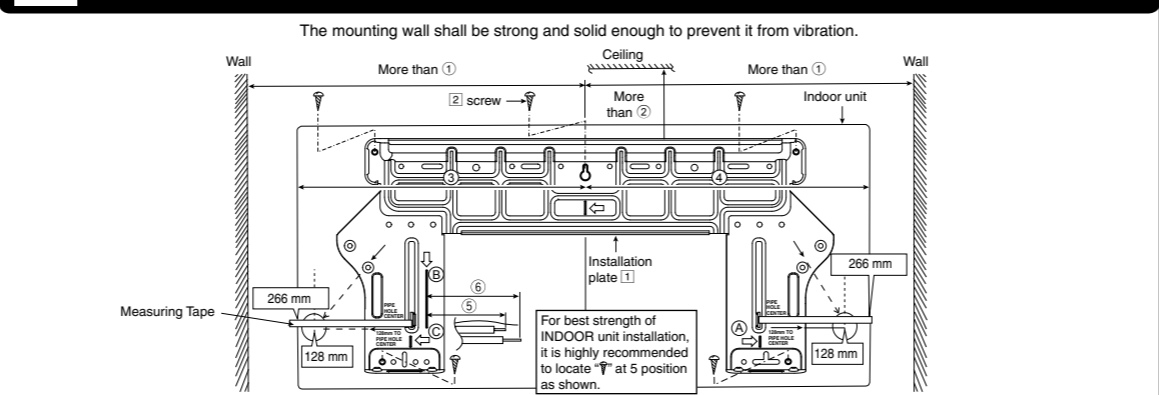

Model	①	②	③	④	⑤	⑥
Z220***, X220*** Z235***, X235*** Z250***, X250*** Z42***, X42***	515 mm	85 mm	460 mm	43 mm	95 mm	

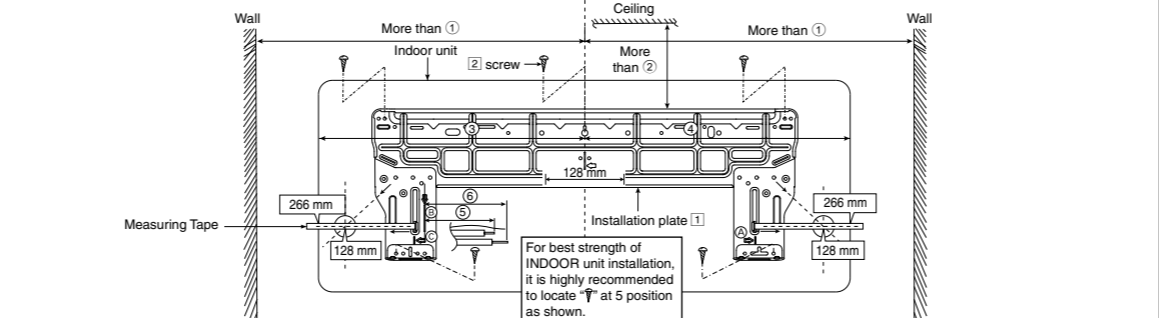

Model	①	②	③	④	⑤	⑥
Z50***, X250*** Z71***	615 mm	95 mm	560 mm	560 mm	270 mm	320 mm

The center of installation plate should be at more than ① at right and left of the wall. The distance from installation plate edge to ceiling should more than ②. From installation plate center to unit's left side is ③. From installation plate center to unit's right side is ④. ⑤: For left side piping, piping connection for liquid should be about ⑤ from this line. ⑥: For left side piping, piping connection for gas should be about ⑥ from this line.

- Keep the installation plate on the wall with 5 screws or more (at least 5 screws). (If mounting the unit on the concrete wall, consider using anchor bolts.)
- Always mount the installation plate horizontally by aligning the marking-off line with the thread and using a level gauge.
- Drill the piping plate hole with φ70 mm hole-core drill.
 - Line according to the left and right side of the installation plate.
 - The meeting point of the extended line is the center of the hole.
 - Another method is by putting measuring tape at position as shown in the diagram above. The hole center is obtained by measuring the distance namely 128 mm from left and right hole respectively.
 - Drill the piping hole at either the right or the left and the hole should be slightly slanting to the outdoor side.

3 TO DRILL A HOLE IN THE WALL AND INSTALL A SLEEVE OF PIPING

- Insert the piping sleeve to the hole.
- Fix the bushing to the sleeve.
- Cut the sleeve until it extrudes about 15 mm from the wall.

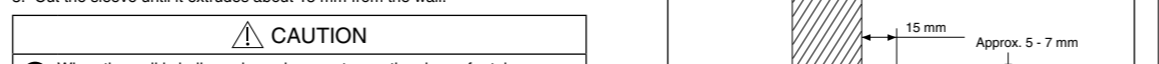

- When the wall is hollow, please be sure to use the sleeve for tube assembly to prevent dangers caused by mice biting the connection cable.
- Finish by sealing the sleeve with putty or caulking compound at the final stage.

5 CONNECT THE CABLE TO THE INDOOR UNIT

The power supply cord, indoor and outdoor unit connection cable can be connected without removing the front grille. ① Install the indoor unit on the installing holder that mounted on the wall. ② Open the front panel and grille door by loosening the screw. ③ Cable connection to the power supply through Isolating Devices (Disconnecting means).

- Connect the approved polychloroethene sheathed power supply cord 3 x 1.5 mm² (3/4-1.75HP) or 3 x 2.5 mm² (2.0-2.5HP), type designation 60245 IEC 57 or heavier cord to the terminal board, and connect the other end of the cable to Isolating Devices (Disconnecting means).
- Do not use joint power supply cord. Replace the wire if the existing wire (from concealed wiring, or otherwise) is too short.
- In unavoidable case, joining of power supply cord between isolating devices and terminal board of air conditioner shall be done by using approved socket and plug rated 15/16A (3/4-1.75HP) or 16A (2.0HP) or 20A (2.5HP). Wiring work to both socket and plug must follow to national wiring standard.
- Bind all the power supply cord lead wire with tape and route the connection cable via the left escapement.
- Connection cable between indoor unit and outdoor unit shall be approved polychloroethene sheathed 4 x 1.5 mm² (3/4-1.75HP) or 4 x 2.5 mm² (2.0-2.5HP) flexible cord, type designation 60245 IEC 57 or heavier cord.
- Bind all the indoor and outdoor connection cable with tape and route the connection cable via the right escapement.
- Remove the tapes and connect the power supply cord and connection cable between indoor unit and outdoor unit according to the diagram below.

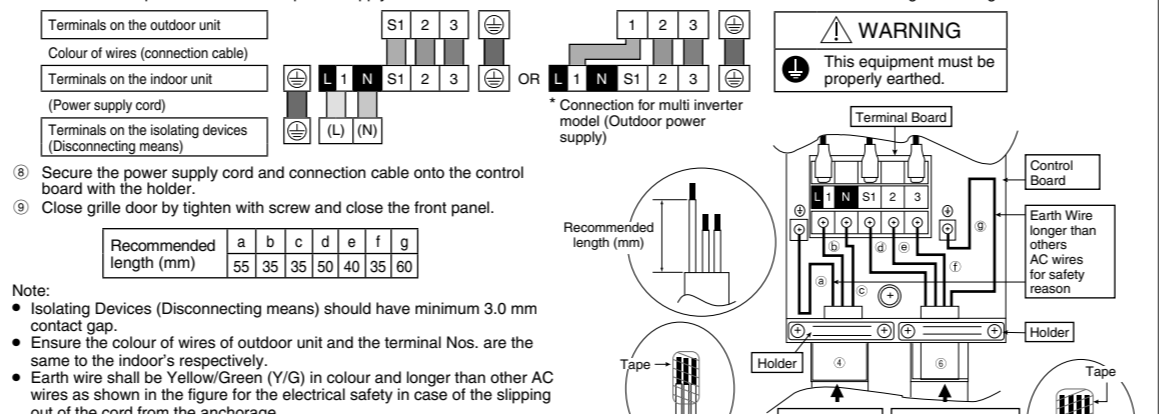

WIRE STRIPPING, CONNECTING REQUIREMENT

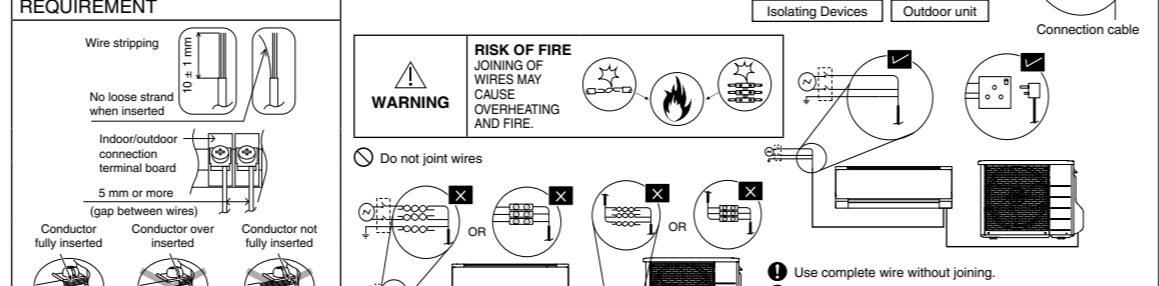

4 INDOOR UNIT INSTALLATION

- Do not turn over the unit without it's shock absorber during pull out the piping. It may cause intake grille damage.
- Use shock absorber during pull out the piping to protect the intake grille from damage.

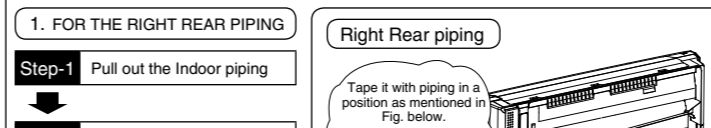

1. FOR THE RIGHT REAR PIPING

- Pull out the indoor piping
- Install the Indoor Unit
- Secure the Indoor Unit
- Insert the power supply cord and connection cable

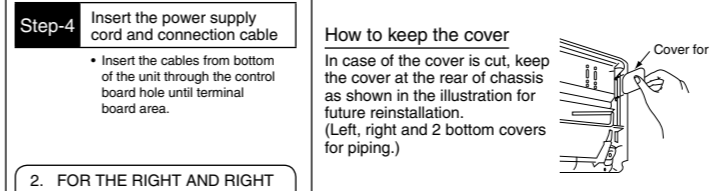

2. FOR THE RIGHT AND RIGHT BOTTOM PIPING

- Pull out the indoor piping
- Install the Indoor Unit
- Insert the power supply cord and connection cable
- Secure the Indoor Unit

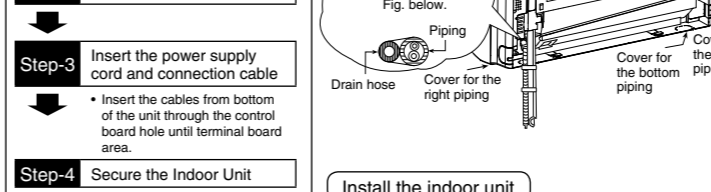

3. FOR THE EMBEDDED PIPING

- Replace the drain hose
- Bend the embedded piping
- Pull the connection cable into Indoor Unit
- Cut and flare the embedded piping
- Install the Indoor Unit
- Connect the piping
- Insulate and finish the piping
- Secure the Indoor Unit

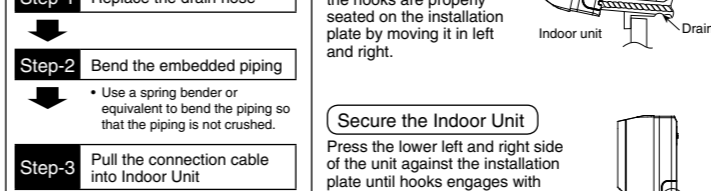

HOW TO TAKE OUT FRONT GRILLE

- Hook the indoor unit onto the upper portion of installation plate.
- Engage the indoor unit with the upper edge of the installation plate. Ensure the hooks are properly seated on the installation plate by moving it in left and right.

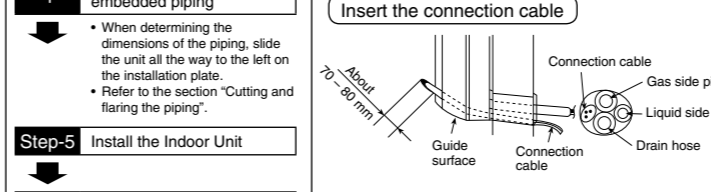

CONNECT THE CABLE TO THE INDOOR UNIT

- Replace the drain hose
- Bend the embedded piping
- Pull the connection cable into Indoor Unit
- Cut and flare the embedded piping
- Install the Indoor Unit
- Connect the piping
- Insulate and finish the piping
- Secure the Indoor Unit

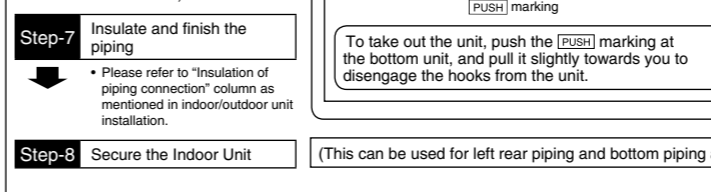

CONNECT THE PIPING

- For connection joint of all model (except R32 model) Please make flare after inserting flare nut (locate at joint portion of tube assembly) onto the copper pipe. (In case of using long piping)
- For connection joint location at inside building for R32 model only

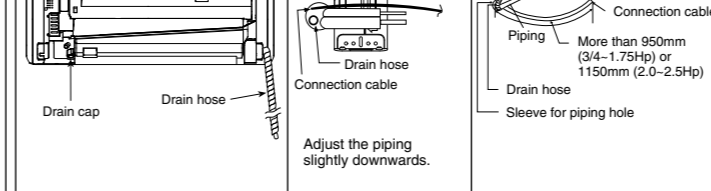

CONNECT THE PIPING TO OUTDOOR

- Decide piping length and then cut by using pipe cutter. Remove burrs from cut edge. Make flare after inserting the flare nut (locate at valve) onto the copper pipe. Align center of piping to valve and then tighten with torque wrench to the specified torque as stated in the table.

Piping size	Torque
6.35 mm (1/4")	[18 N•m (1.8 kgf•m)]
9.52 mm (3/8")	[42 N•m (4.3 kgf•m)]
12.7 mm (1/2")	[55 N•m (5.6 kgf•m)]
15.88 mm (5/8")	[65 N•m (6.6 kgf•m)]
19.05 mm (3/4")	[100 N•m (10.2 kgf•m)]

CONNECTING THE PIPING TO OUTDOOR MULTI

- Decide piping length and then cut by using pipe cutter. Remove burrs from cut edge. Make flare after inserting the flare nut (locate at valve) onto the copper pipe. Align center of piping to valve and then tighten with torque wrench to the specified torque as stated in the table.

Piping size	Torque
6.35 mm (1/4")	[18 N•m (1.8 kgf•m)]
9.52 mm (3/8")	[42 N•m (4.3 kgf•m)]
12.7 mm (1/2")	[55 N•m (5.6 kgf•m)]
15.88 mm (5/8")	[65 N•m (6.6 kgf•m)]
19.05 mm (3/4")	[100 N•m (10.2 kgf•m)]

CONNECT THE PIPING

CONNECTING THE PIPING TO OUTDOOR MULTI

- Decide piping length and then cut by using pipe cutter. Remove burrs from cut edge. Make flare after inserting the flare nut (locate at valve) onto the copper pipe. Align center of piping to valve and then tighten with torque wrench to the specified torque as stated in the table.

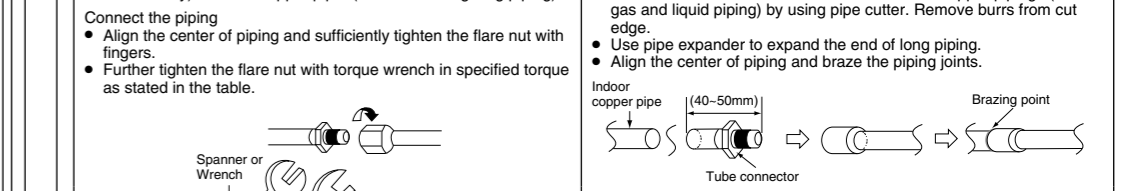

CUTTING AND FLARING THE PIPING

- Please cut using pipe cutter and then remove the burrs.
- Remove the burrs by using reamer. If burrs is not removed, gas leakage may be caused. Turn the piping end down to avoid the metal powder entering the pipe.
- Please make flare after inserting the flare nut onto the copper pipes.

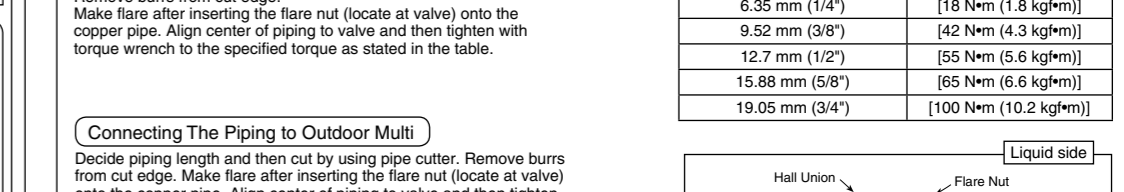

HOW TO TAKE OUT FRONT GRILLE

- Set the vertical airflow direction louvers to the horizontal position.
- Remove the 2 caps (1.0-1.75HP) or 3 caps (2.0-2.5HP) on the front grille as shown in the illustration at right.
- And then remove the 3 (1.0-1.75HP) or 4 (2.0-2.5HP) mounting screws.
- Pull the lower section of the front grille towards you to remove the front grille.

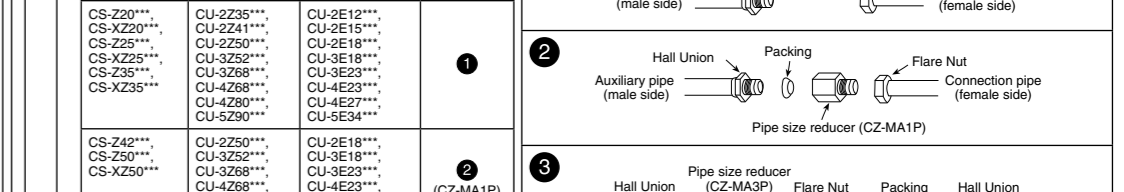

AUTO SWITCH OPERATION

- TEST RUN OPERATION (FOR PUMP DOWN/SERVICING PURPOSE) The Test Run operation will be activated if the Auto Switch is pressed continuously for more than 5 sec. to below 8 sec. A "pep" sound will occur at the fifth sec., in order to identify the starting of Test Run operation.
- HEATING TRIAL OPERATION Press the "AUTO" switch continuously for more than 8 sec. to below 11 sec. and release when a "pep pep" sound is occurred at eighth sec. (However, a "pep" sound is occurred at fifth sec.) Then press Remote controller "AC Reset" button once. Remote controller signal will activate operation to force heating mode.
- REMOTE CONTROLLER RECEIVING SOUND ON/OFF The ON/OFF of Remote controller receiving sound can be change over by the following steps: a) Press "AUTO" switch continuously for more than 16 sec. to below 21 sec. A "pep", "pep", "pep" sound will occur at the sixteenth sec. b) Press the "AC Reset" button once, "pep" sound will occur indicates that Remote controller receiving sound setting mode is activated. c) Press "AUTO" switch again. Everytime "AUTO" switch is pressed (within 60 sec. interval), Remote controller receiving sound status will be reversed between ON and OFF. d) Long "pep" sound indicates that Remote controller receiving sound is ON. Short "pep" sound indicates that Remote controller receiving sound is OFF.
- HEATING ONLY OPERATION Press the "AUTO" switch continuously for more than 8 sec. to below 11 sec. And release when a "pep pep" sound is occurred at eighth sec. (However, a "pep" sound is occurred at fifth sec.) Then press Remote controller "Check" button once. Remote controller signal will activate heating only operation mode.

ECO SENSOR

- Do not hit or violently press the sensor.
- This can lead to damage and malfunction.
- Do not place large objects near the sensor and keep heating units or humidifiers away from the sensors detection area. This may lead to sensor malfunction.

CHECK THE DRAINAGE

- Open front panel and remove air filters. (Drainage checking can be carried out without removing the front grille.)
- Pour a glass of water into the drain tray-styrofoam.
- Ensure that water flows out from drain hose of the indoor unit.

EVALUATION OF THE PERFORMANCE

- Operate the unit at cooling/heating operation mode for fifteen minutes or more.
- Measure the temperature of the intake and discharge air.
- Ensure the difference between the intake temperature and the discharge is more than 8°C during Cooling operation or more than 14°C during Heating operation.

CHECK ITEMS

- Is there any gas leakage at flare nut connections?
- Has the heat insulation been carried out at flare nut connection?
- Is the connection cable being fixed to terminal board firmly?
- Is the connection cable being clamped firmly?
- Is the drainage OK