

Panasonic**INSTALLATION INSTRUCTIONS OUTDOOR UNIT**

3HP	4HP	5HP	6HP
U-71PZH2E5	U-100PZH2E5	U-125PZH2E5	U-140PZH2E5
U-71PZH2E8	U-100PZH2E8	U-125PZH2E8	U-140PZH2E8

⚠ CAUTION**R32
REFRIGERANT**

This Air Conditioner contains and operates with refrigerant R32. THIS PRODUCT MUST ONLY BE INSTALLED OR SERVICED BY QUALIFIED PERSONNEL. Refer to Commonwealth, State, Territory and local legislation, regulations, codes, installation & operating instructions, before the installation, maintenance and/or service of this product.

Refer to the indoor unit installation instruction manual for the indoor unit installation.

Note: Ensure to hand over this installation instruction manual to the person performing the installation and inform the customer to keep it properly stored.

- Refer to the caution items listed in “5.REFRIGERANT INSTALLATION” for the installation of the refrigerant piping and maintain strict control concerning the prevention of mixing impurities (water and mineral oils such as Suniso oils) with R32.
- The indoor unit to be connected must be R32 compatible and be sure to check the catalogue, etc. for available models. The product may not operation properly if connected to other indoor units.

PRECAUTIONS IN TERMS OF SAFETY

Carry out installation work with reliability after thorough reading of this “Precaution in terms of safety”.

- Precautions shown here are differentiated between **⚠WARNING** and **⚡CAUTION**. Those that have much chances for leading to significant result such as fatality or serious injury if wrong installation would have been carried out are listed compiling them especially into the column of **⚠WARNING**.

However, even in the case of items which are listed in the column of **⚡CAUTION**, such items also have a chance for leading to significant result depending on the situations. In either case, important descriptions regarding the safety are listed, then observe them without fail.

- As to indications with illustration.

⚠ This mark means “CAUTION” or “WARNING”. **⚡ This mark means “protective earth”.**

The items to be followed are classified by symbols:

	Symbol with white background denotes item that is PROHIBITED.
	Symbol with dark background denotes item that must be carried out.

- After installation work has been completed, do not only make sure that the unit is free from any abnormal condition through the execution of try run but also explain how to use and how to perform maintenance of this unit to the customer according to the operating instructions. In addition, request the customer to keep this installation instructions for installation work together with operating instructions.

⚠ WARNING

- Do not use means to accelerate the defrosting process or to clean, other than those recommended by the manufacturer. The appliance shall be stored in a room without continuously operating ignition sources (for example: open flames, an operating gas appliance or an operating electric heater.) Do not pierce or burn. Be aware that refrigerants may not contain an odour. Appliance shall be installed, operated and stored in a room with a floor area larger than (A_{min}) m². As for (A_{min}), see the section “Check of Density Limit”.
- An unventilated area where the appliance using flammable refrigerants is installed shall be so constructed that should any refrigerant leak, it will not stagnate so as to create a fire or explosion hazard.
- The appliance shall be stored in a well-ventilated area where the room size corresponds to the room area as specified for operation.
- The appliance shall be stored in a room without continuously operating open flames (for example an operating gas appliance) and ignition sources (for example an operating electric heater).
- Do not sit or step on the unit, you may fall down accidentally.
- Do not install outdoor unit near handrail of veranda. When installing air-conditioner unit on veranda of a high rise building, child may climb up to outdoor unit and cross over the handrail causing an accident.
- Do not insert your fingers or other objects into the FAN CASE, you may be injured and the unit may be damaged.
- When performing piping work do not mix air except for specified refrigerant (R32) in refrigeration cycle. It causes capacity down, and risk of explosion and injury due to high tension inside the refrigerant cycle.
- Do not add or replace refrigerant other than specified type. It may cause product damage, burst and injury etc.
- Do not clean inside the indoor and outdoor units by users. Engage authorized dealer or specialist for cleaning.
- In case of malfunction of this appliance, do not repair by yourself. Contact to the sales dealer or service dealer for a repair.
- Must not use other parts except original optional parts described in catalogue and manual.

- The appliance shall be stored so as to prevent mechanical damage from occurring.
- Keep plastic bag (packaging material) away from small children, it may cling to nose and mouth and prevent breathing.
- The appliance must be installed by technician, who takes into account the requirements given by ISO 5149 or eventual equivalent requirements.
- As to installation, request the distributor or vendor to perform it.
- Imperfection in installation caused by that having been carried out by the customer himself may lead to water leakage, electric shock, fire, etc.
- Carry out the installation work with reliability according to this manual for installation work. Imperfection in installation leads to water leakage, electric shock, fire, etc.
- Carry out the installation work with reliability on the place that can bear the weight of this unit sufficiently. Insufficient strength leads to injury due to falling of the unit.
- Carry out predetermined installation work in preparation for strong wind such as typhoon, earthquake. Imperfection in installation work may lead to accidents arising from overturn, etc.
- If installing inside a small room, measures should be taken to prevent refrigerant levels from building up to critical concentrations in the event of a refrigerant leak occurring.
- Please discuss with the place of purchase for advice on what measures may be necessary to prevent critical concentrations being exceeded.
- If the refrigerant leaks and reaches critical concentration levels, there is the danger that death from suffocation may result.
- Be careful when picking up and moving the indoor and outdoor units.
- Get a partner to help, and bend your knees when lifting to reduce strain on your back. Sharp edges or thin aluminum fins on the air conditioner can cut your fingers.
- During pump-down operation must stop the compressor before disconnecting the piping installation. (Disconnecting the refrigerant piping, while the compressor is operating with the 3-way valve opened, leads to air intake and an abnormal high pressure in the refrigerant cycle which can cause an explosion and / or injury.)

- During installation, ensure that the refrigerant piping is installed before operating the compressor. (Do not install the refrigerant piping while the compressor is operating with the 3-way valve opened, as this leads to air intake and an abnormal high pressure in the refrigerant cycle which may cause an explosion and / or injury.)

- If refrigerant gas escaped during installation, ventilate the affected area.
- If the refrigerant gas comes into contact with sparks or naked flames, it will cause toxic gases to be generated.

- The unit must be installed in accordance with applicable national and local regulations.
- Any electrical work should only be carried out by qualified technician and use exclusive circuits without fail. Presence of insufficient capacity in power circuit or imperfection in execution leads to electric shock, fire, etc.

- Wiring shall be connected securely using specified cables and fix them securely so that external force of the cables may not transfer to the terminal connection section. Imperfect connection and fixing leads to fire, etc.

- Securely attach the protective covers for the outdoor unit connection cables and power cord so that they do not lift up after installation.
- If the covers are not properly attached and installed, the terminal connections may overheat and fire or electric shock may result.

- Switch off all supplies before accessing any electrical part.

- Improper fixing of screw may cause leakage current and electrical shock.

- Earth
- This equipment must be properly earthed. Earth line must not be connected to gas pipe, water pipe, lightning rod and telephone. Otherwise, it may cause electrical shock in case the equipment breakdown or has leakage current.

- Provide a power outlet exclusively for each unit, and full disconnection means having a contact separation in all poles must be incorporated in the fixed wiring in accordance with the wiring rules.

- Installation of Earth Leakage Current Breaker
- This equipment must be installed with earth leakage current breaker. Otherwise, it may cause electrical shock and fire in case the equipment breakdown or has leakage current.

- Cables connected to outdoor unit must be approved polychloroprene sheathed type 60245 IEC 57 or H05RN-F/H07RN-F or heavier.

- The units must be connected to the supply cables for fixed wiring by qualified technician.
- Circuit breaker must be incorporated in the fixed wiring in accordance with the national wiring regulations.

- The circuit breaker must be approved, suitable for the voltage and current ratings of equipment and have a contact separation by 3mm in all poles. When the supply cable is damaged, it must be replaced by qualified technician.

- Be sure to install a current leakage breaker, main switch and fuse to the main power supply, otherwise electric shock may result.

- Once installation work is completed, check that there are no refrigerant gas in the room that can come into contact with sparks or flames from a fan heater, stove or kitchen range, which will cause toxic gases to be generated.

⚡ CAUTION

- Do not install the unit at the place where the possibility of inflammable gas leakage exists. If such gas leakages should arise and the gas builds up around the unit, such situation may lead to ignition.
- Do not touch the air inlet or the sharp aluminium fin, you may get injured.
- Be sure that the shield part of the shielded cable does not touch the terminal block or any live parts. Failure to do so may lead to electric shock or fire.
- Drain piping should be made to ensure secure drainage according to the manual for installation work and carry out the thermal insulation to prevent the occurrence of condensation. Imperfection in piping work leads to water leakage and may cause the house and property, etc. to become wet.
- Position the indoor unit and outdoor unit, power cords and indoor / outdoor unit connection cables in a way so that they are at least 1 meter away from televisions and radios. This is to avoid problems such as interference with picture and / or sound. (However, note that depending on the electromagnetic wave conditions, interference may still occur even if the separation distance is more than 1 meter.)
- When fixing the product with an overturn prevention wire, care should be taken to choose a place where no one trips over the fixing wire.
- Before wiring confirm the rated voltage of the unit as shown on its nameplate, then carry out the wiring closely following the wiring diagram.

PRECAUTION FOR USING R32 REFRIGERANT

- The basic installation work procedures are the same as conventional refrigerant (R410A, R22) models.

However, pay careful attention to the following points:

⚠ WARNING

- Since the working pressure is higher than that of refrigerant R22 models, some of the piping and installation and service tools are special.
- Models that use refrigerant R32 and R410A have a different charging port thread diameter to prevent erroneous charging with refrigerant R22 and for safety. Therefore, check beforehand.
- Be more careful than R22 so that foreign matter (oil, water, etc.) does not enter the piping.
- Also, when storing the piping, securely seal the opening by pinching, taping, etc. (Handling of R32 is similar to R410A.)

⚡ CAUTION

- Installation (Space)
 - That the installation of pipe-work shall be kept to a minimum.
 - Must ensure that pipe-work shall be protected from physical damage.
 - That compliance with national gas regulations shall be observed.
 - Must ensure mechanical connections be accessible for maintenance purposes.
 - In cases that require mechanical ventilation, ventilation openings shall be kept clear of obstruction.
 - When disposal of the product, do follow to the precautions in #12 and comply with national regulations. Always contact to local municipal offices for proper handling.
- Servicing
 - 2-1. Service personnel**
 - Any qualified person who is involved with working on or breaking into a refrigerant circuit should hold a current valid certificate from an industry-accredited assessment authority, which authorizes their competence to handle refrigerants safely in accordance with an industry recognised assessment specification.

- Servicing shall only be performed as recommended by the equipment manufacturer. Maintenance and repair requiring the assistance of other skilled personnel shall be carried out under the supervision of the person competent in the use of flammable refrigerants.
- Servicing shall be performed only as recommended by the manufacturer.

2-2. Work

- Prior to beginning work on systems containing flammable refrigerants, safety checks are necessary to ensure that the risk of ignition is minimised.
- For repair to the refrigerating system, #2-3 to #2-7 shall be completed prior to conducting work on the system.
- Work shall be undertaken under a controlled procedure so as to minimise the risk of a flammable gas or vapour being present while the work is being performed.

2-3. General work area

- All maintenance staff and others working in the local area shall be instructed on the nature of work being carried out.
- Work in confined spaces shall be avoided.
- The area around the workspace shall be sectioned off.
- Ensure that the conditions within the area have been made safe by control of flammable material.

2-4. Checking for presence of refrigerant

- The area shall be checked with an appropriate refrigerant detector prior to and during work, to ensure the technician is aware of potentially toxic or flammable atmospheres.
- Ensure that the leak detection equipment being used is suitable for use with all applicable refrigerants, i.e. non-sparking, adequately sealed or intrinsically safe.

2-5. Presence of fire extinguisher

- If any hot work is to be conducted on the refrigeration equipment or any associated parts, appropriate fire extinguishing equipment shall be available to hand.
- Have a dry powder or CO₂ fire extinguisher adjacent to the charging area.

2-6. No ignition sources

- No person carrying out work in relation to a refrigeration system which involves exposing any pipe work shall use any sources of ignition in such a manner that it may lead to the risk of fire or explosion.
- All possible ignition sources, including cigarette smoking, should be kept sufficiently far away from the site of installation, repairing, removing and disposal, during which refrigerant can possibly be released to the surrounding space.
- Prior to work taking place, the area around the equipment is to be surveyed to make sure that there are no flammable hazards or ignition risks.
- “No Smoking” signs shall be displayed.

2-7.Ventilated area

- Ensure that the area is in the open or that it is adequately ventilated before breaking into the system or conducting any hot work.
- A degree of ventilation shall continue during the period that the work is carried out.
- The ventilation should safely disperse any released refrigerant and preferably expel it externally into the atmosphere.

2-8. Checks to the refrigeration equipment

- Where electrical components are being changed, they shall be fit for the purpose and to the correct specification.
- At all times the manufacturer’s maintenance and service guidelines shall be followed.
- If in doubt, consult the manufacturer’s technical department for assistance.
 - The charge size is in accordance with the room size within which the refrigerant containing parts are installed;
 - The ventilation machinery and outlets are operating adequately and are not obstructed;
 - Marking to the equipment continues to be visible and legible. Markings and signs that are illegible shall be corrected;
 - Refrigeration pipe or components are installed in a position where they are unlikely to be exposed to any substance which may corrode refrigerant containing components, unless the components are constructed of materials which are inherently resistant to being corroded or are suitably protected against being so corroded.

2-9. Checks to electrical devices

- Repair and maintenance to electrical components shall include initial safety checks and component inspection procedures.
- If a fault exists that could compromise safety, then no electrical supply shall be connected to the circuit until it is satisfactorily dealt with.
- If the fault cannot be corrected immediately but it is necessary to continue operation, an adequate temporary solution shall be used.
- This shall be reported to the owner of the equipment so all parties are advised.
- Initial safety checks shall include:
 - That no live electrical components and wiring are exposed while charging, recovering or purging the system;
 - That there is continuity of earth bonding.

- Repairs to sealed components
 - During repairs to sealed components, all electrical supplies shall be disconnected from the equipment being worked upon prior to any removal of sealed covers, etc.
 - Particular attention shall be paid to the following to ensure that by working on electrical components, the casing is not altered in such a way that the level of protection is affected. This shall include damage to cables, excessive number of connections, terminals not made to original specification, damage to seals, incorrect fitting of glands, etc.
 - Ensure that apparatus is mounted securely.
 - Ensure that seals or sealing materials have not degraded to the point that they no longer serve the purpose of preventing the ingress of flammable atmospheres.
 - Replacement parts shall be in accordance with the manufacturer’s specifications.

NOTE: The use of silicon sealant can inhibit the effectiveness of some types of leak detection equipment. Intrinsically safe components do not have to be isolated prior to working on them.

- Repair to intrinsically safe components
 - Do not apply any permanent inductive or capacitance loads to the circuit without ensuring that this will not exceed the permissible voltage and current permitted for the equipment in use.
 - Intrinsically safe components are the only types that can be worked on while live in the presence of a flammable atmosphere. The test apparatus shall be at the correct rating.
 - Replace components only with parts specified by the manufacturer.
 - Other parts may result in the ignition of refrigerant in the atmosphere from a leak.

- Cabling
 - Check that cabling will not be subject to wear, corrosion, excessive pressure, vibration, sharp edges or any other adverse environmental effects.
 - The check shall also take into account the effects of aging or continual vibration from sources such as compressors or fans.

- Detection of flammable refrigerants
 - Under no circumstances shall potential sources of ignition be used in the searching for or detection of refrigerant leaks.
 - A halide torch (or any other detector using a naked flame) shall not be used.

- Leak detection methods
 - Electronic leak detectors may be used to detect refrigerant leaks but, in the case of flammable refrigerants, the sensitivity may not be adequate, or may need re-calibration. (Detection equipment shall be calibrated in a refrigerant-free area.)

- Ensure that the detector is not a potential source of ignition and is suitable for the refrigerant used.
- Leak detection equipment shall be set at a percentage of the LFL of the refrigerant and shall be calibrated to the refrigerant employed, and the appropriate percentage of gas (25 % maximum) is confirmed.
- Leak detection fluids are suitable for use with most refrigerants but the use of detergents containing chlorine shall be avoided as the chlorine may react with the refrigerant and corrode the copper pipe-work.
- If a leak is suspected, all naked flames shall be removed/extinguished.
- If a leakage of refrigerant is found which requires brazing, all of the refrigerant shall be recovered from the system, or isolated (by means of shut off valves) in a part of the system remote from the leak. For appliances containing flammable refrigerants, oxygen free nitrogen (OFN) shall then be purged through the system both before and during the brazing process.

- Removal and evacuation
 - When breaking into the refrigerant circuit to make repairs-or for any other purpose-conventional procedures shall be used.
 - However, it is important that best practice is followed since flammability is a consideration.The following procedure shall be adhered to:
 - remove refrigerant;
 - purge the circuit with inert gas;
 - evacuate;
 - purge again with inert gas;
 - open the circuit by cutting or brazing.
 - The refrigerant charge shall be recovered into the correct recovery cylinders.
 - The system shall be “flushed” with OFN to render the unit safe. This process may need to be repeated several times.
 - Compressed air or oxygen shall not be used for purging refrigerant systems.
 - Flushing shall be achieved by breaking the vacuum in the system with OFN and continuing to fill until the working pressure is achieved, then venting to atmosphere, and finally pulling down to a vacuum.
 - This process shall be repeated until no refrigerant is within the system.
 - When the final OFN charge is used, the system shall be vented down to atmospheric pressure to enable work to take place.
 - This operation is absolutely vital if brazing operations on the pipe-work are to take place.
 - Ensure that the outlet for the vacuum pump is not close to any ignition sources and that ventilation is available.

- Charging procedures
 - In addition to conventional charging procedures, the following requirements shall be followed.
 - Ensure that contamination of different refrigerants does not occur when using charging equipment.
 - Hoses or lines shall be as short as possible to minimize the amount of refrigerant contained in them.
 - Cylinders shall be kept upright.
 - Ensure that the refrigeration system is earthed prior to charging the system with refrigerant.
 - Label the system when charging is complete (if not already).
 - Extreme care shall be taken not to over fill the refrigeration system.
 - Prior to recharging the system it shall be pressure tested with OFN (refer to #7).
 - The system shall be leak tested on completion of charging but prior to commissioning.
 - A follow up leak test shall be carried out prior to leaving the site.
 - Electrostatic charge may accumulate and create a hazardous condition when charging and discharging the refrigerant.
 - To avoid fire or explosion, dissipate static electricity during transfer by grounding and bonding containers and equipment before charging/discharging.

- Decommissioning
 - Before carrying out this procedure, it is essential that the technician is completely familiar with the equipment and all its detail.
 - It is recommended good practice that all refrigerants are recovered safely.
 - Prior to the task being carried out, an oil and refrigerant sample shall be taken in case analysis is required prior to re-use of reclaimed refrigerant.
 - It is essential that electrical power is available before the task is commenced.

- Become familiar with the equipment and its operation.
- Isolate system electrically.
- Before attempting the procedure ensure that:
 - mechanical handling equipment is available, if required, for handling refrigerant cylinders;
 - all personal protective equipment is available and being used correctly;
 - the recovery process is supervised at all times by a competent person;
 - recovery equipment and cylinders conform to the appropriate standards.
- Pump down refrigerant system, if possible.
- If a vacuum is not possible, make a manifold so that refrigerant can be removed from various parts of the system.
- Make sure that cylinder is situated on the scales before recovery takes place.
- Start the recovery machine and operate in accordance with manufacturer’s instructions.
- Do not overfill cylinders. (No more than 80 % volume liquid charge).
- Do not exceed the maximum working pressure of the cylinder, even temporarily.
- When the cylinders have been filled correctly and the process completed, make sure that the cylinders and the equipment are removed from site promptly and all isolation valves on the equipment are closed off.
- Recovered refrigerant shall not be charged into another refrigeration system unless it has been cleaned and checked.

- Electrostatic charge may accumulate and create a hazardous condition when charging or discharging the refrigerant. To avoid fire or explosion, dissipate static electricity during transfer by grounding and bonding containers and equipment before charging/discharging.

- Labelling
 - Equipment shall be labelled stating that it has been de-commissioned and emptied of refrigerant.
 - The label shall be dated and signed.
 - Ensure that there are labels on the equipment stating the equipment contains flammable refrigerant.

- Recovery
 - When removing refrigerant from a system, either for servicing or decommissioning, it is recommended good practice that all refrigerants are removed safely.
 - When transferring refrigerant into cylinders, ensure that only appropriate refrigerant recovery cylinders are employed.
 - Ensure that the correct number of cylinders for holding the total system charge are available.
 - All cylinders to be used are designated for the recovered refrigerant and labelled for that refrigerant (i.e. special cylinders for the recovery of refrigerant).
 - Cylinders shall be complete with pressure-relief valve and associated shut-off valves in good working order.
 - Empty recovery cylinders are evacuated and, if possible, cooled before recovery occurs.
 - The recovery equipment shall be in good working order with a set of instructions concerning the equipment that is at hand and shall be suitable for the recovery of all appropriate refrigerants including, when applicable, flammable refrigerants.
 - In addition, a set of calibrated weighing scales shall be available and in good working order.
 - Hoses shall be complete with leak-free disconnect couplings and in good condition.
 - Before using the recovery machine, check that it is in satisfactory working order, has been properly maintained and that any associated electrical components are sealed to prevent ignition in the event of a refrigerant release.
 - Consult manufacturer if in doubt.
 - The recovered refrigerant shall be returned to the refrigerant supplier in the correct recovery cylinder, and the relevant waste transfer note arranged.
 - Do not mix refrigerants in recovery units and especially not in cylinders.
 - If compressors or compressor oils are to be removed, ensure that they have been evacuated to an acceptable level to make certain that flammable refrigerant does not remain within the lubricant.
 - The evacuation process shall be carried out prior to returning the compressor to the suppliers.
 - Only electric heating to the compressor body shall be employed to accelerate this process.
 - When oil is drained from a system, it shall be carried out safely.

Explanation of symbols displayed on the indoor unit or outdoor unit.

- WARNING: This symbol shows that this equipment uses a flammable refrigerant. If the refrigerant is leaked, together with an external ignition source, there is a possibility of ignition.
CAUTION: This symbol shows that the Operating Instructions should be read carefully.
CAUTION: This symbol shows that a service personnel should be handling this equipment with reference to the Technical Manual.
CAUTION: This symbol shows that there is information included in the Operating Instructions and/or Installation Instructions.

Check of Density Limit

The refrigerant (R32), which is used in the air conditioner, is a flammable refrigerant. So the requirements for installation space of appliance are determined according to the refrigerant charge amount (m) used in the appliance.

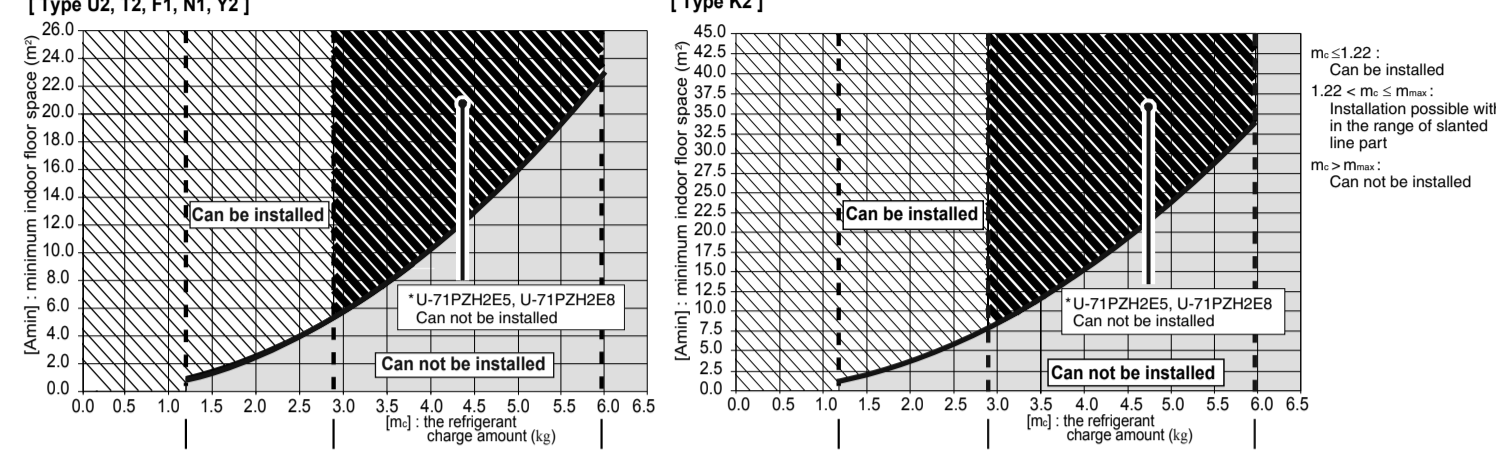

2.850 indicates m_min digit of the model U-71PZH2E5, U-71PZH2E8, U-100PZH2E5, U-100PZH2E8, U-125PZH2E5, U-125PZH2E8, and U-140PZH2E5, U-140PZH2E8.
5.975 indicates m_max digit of the model U-71PZH2E5, U-71PZH2E8, U-100PZH2E5, U-100PZH2E8, U-125PZH2E5, U-125PZH2E8, and U-140PZH2E5, U-140PZH2E8.

1. ACCESSORIES SUPPLIED WITH OUTDOOR UNIT

Table with columns: Part name, Qty, Diagram, Application. Lists items like Protective bushing, Banding strap, and their uses.

2. PLEASE INSTALL ACCORDING TO [Warning] [Caution] on page 1.

Be careful when picking up and moving the indoor and outdoor units. Get a partner to help, and bend your knees when lifting to reduce strain on your back. Sharp edges or thin aluminum fins on the air conditioner can cut your fingers.

- 1. Install the unit once you have checked that the installation location matches the following conditions.
2. Refer to the diagram below for the installation location which is exposed to strong wind.

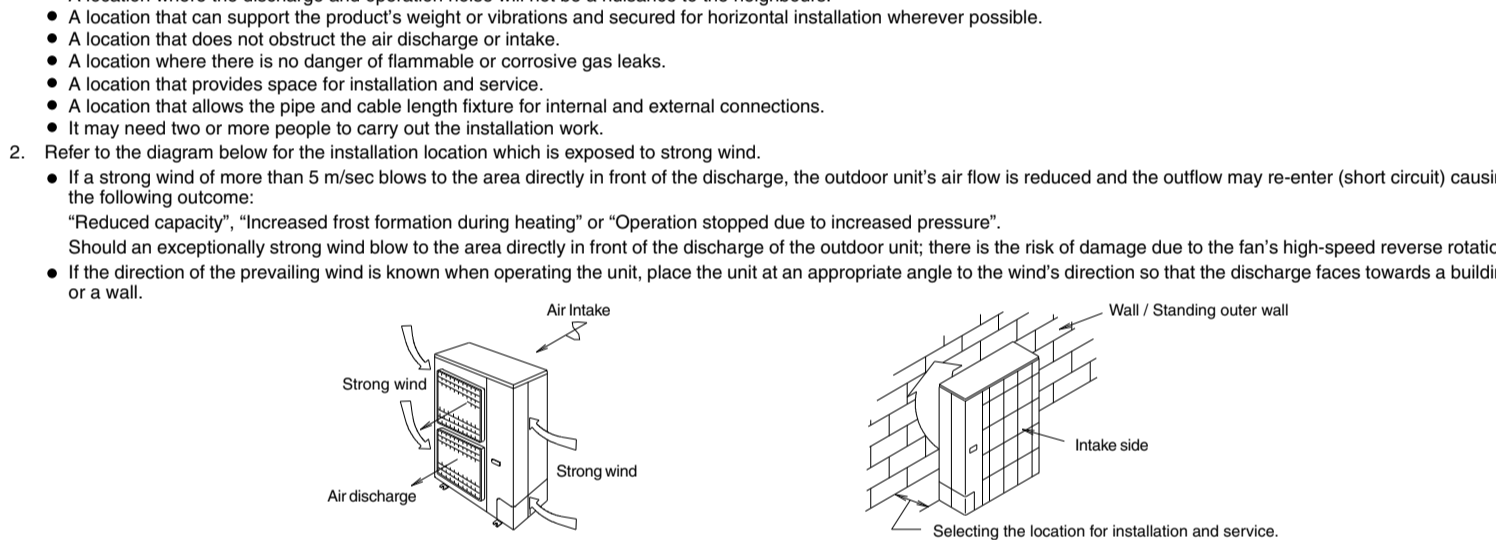

3. SELECTING THE LOCATION FOR INSTALLATION SERVICE

Please secure necessary space to guarantee performance and service & maintenance. For multiple installations, please secure enough space to enable removal of side face screws between units. (unit/mtr)

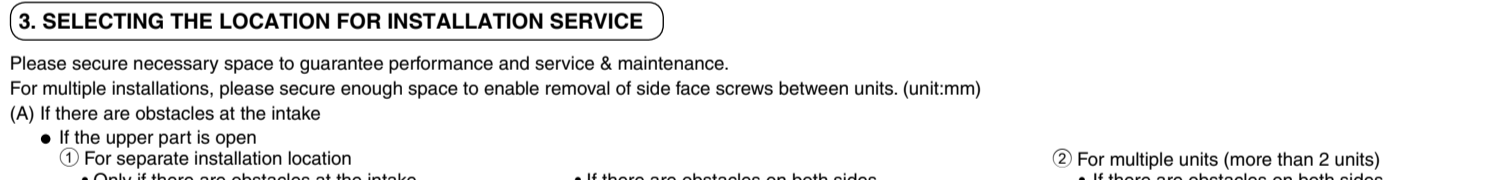

5. REFRIGERANT INSTALLATION

For indoor unit refrigerant piping installation, refer to the installation instruction manual that comes with that indoor unit.
1. Precautions during refrigerant installation.
2. The local pipes can protrude from the four piping directions.

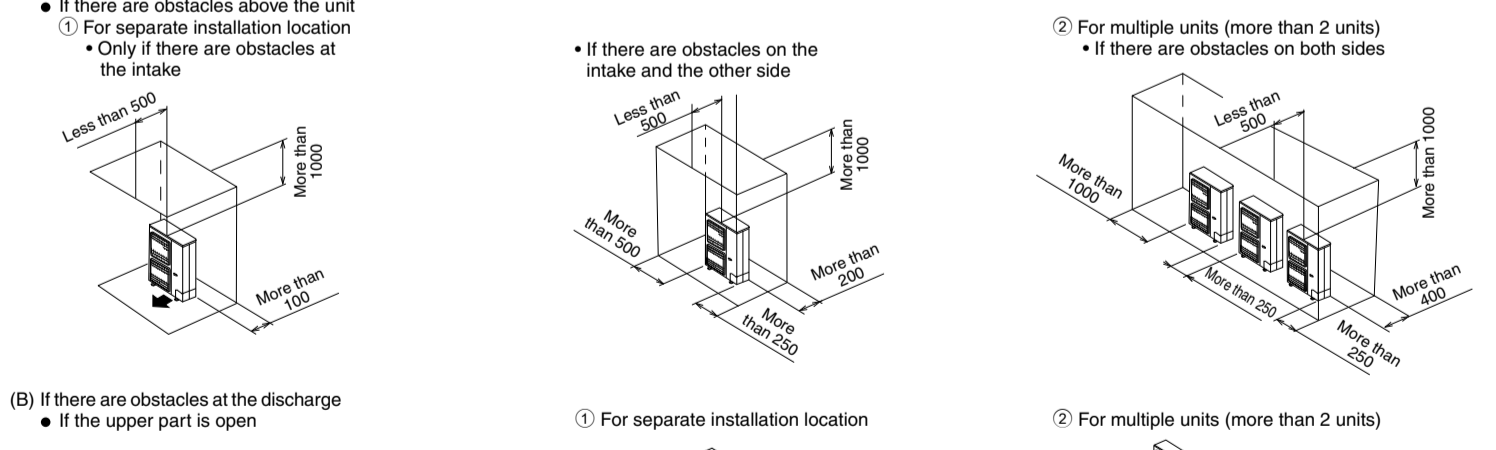

Specification for pipe connecting indoor unit to outdoor unit. Table with columns for U-71 and U-100/125/140 models, listing maximum pipe length, height difference, charge-less pipe length, etc.

Precautions when operating the 3-way valve for piping installation.
1. Do not open the 3-way valve until the piping installation is completed.
2. Direction to pull out wires.

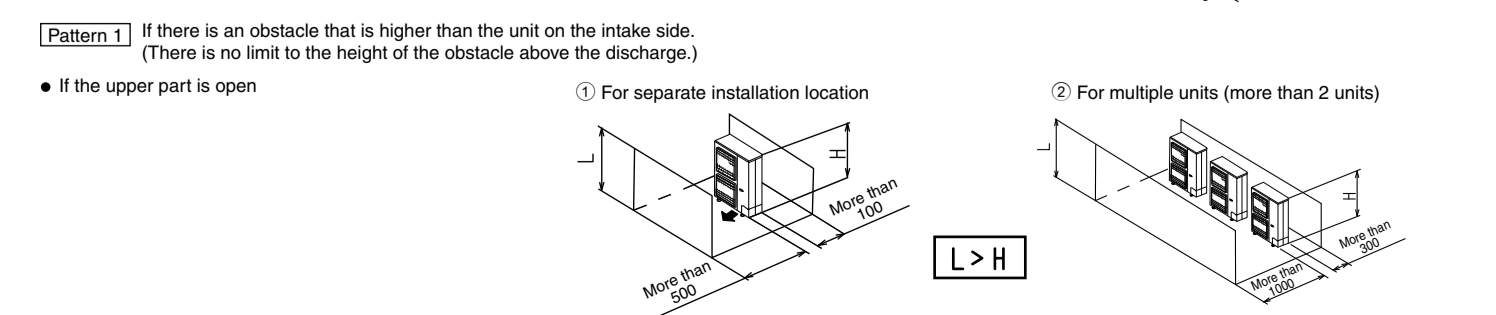

- If there are obstacles above the unit.
For separate installation location.
For multiple units (up to 2 units).
If there are obstacles at the discharge.
If the upper part is open.

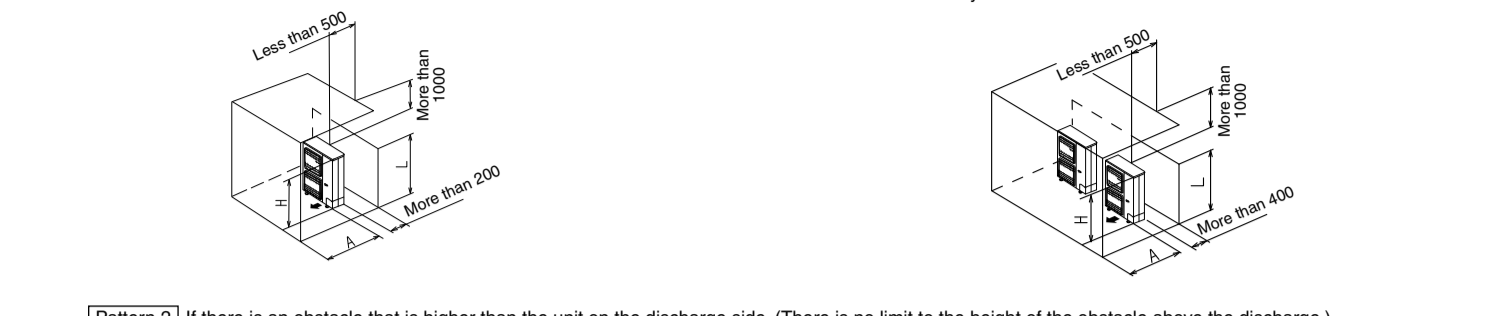

- If there are obstacles above the unit.
For separate installation location.
For multiple units (more than 2 units).

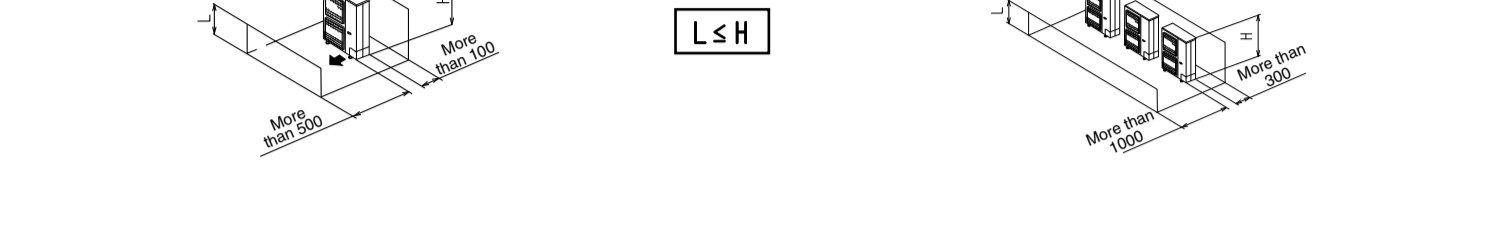

- If there are obstacles above the unit.
For separate installation location.
For multiple units (up to 2 units).
If there are obstacles at the discharge.



(D) Stacking installation setup.
1. Stack up to 2 tiers.
2. A dimension of approximately 400 mm is required for the second tier outdoor units drain pipe and space for maintenance of the first tier outdoor unit.



Dimensions for H, A, and L. Table with columns for L, S, H and H, L, A, showing installation possibilities.

4. TRANSPORT AND INSTALL THE OUTDOOR UNIT

- Transporting: Transport the outdoor unit in its original packaging as close as possible to the installation location.
Installation: Read the 'Select the outdoor unit installation location' thoroughly before installing the outdoor unit.
Drainage: The drain water will be discharged from the unit during heating or defrosting operation mode.

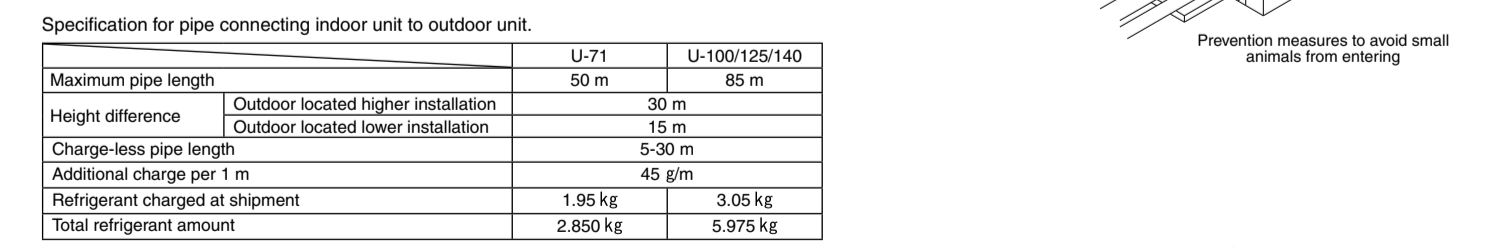
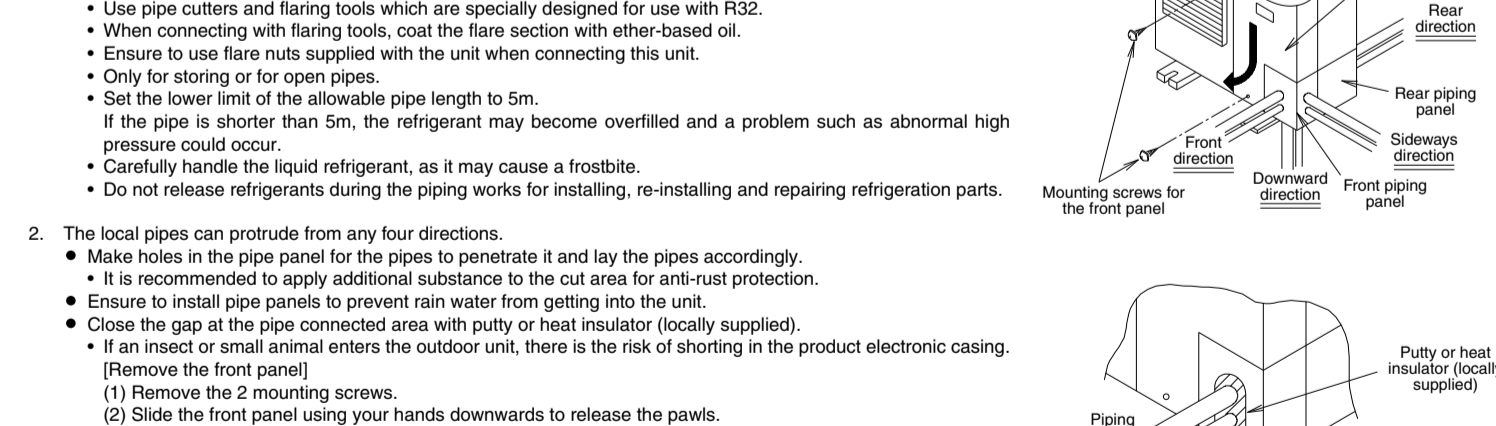
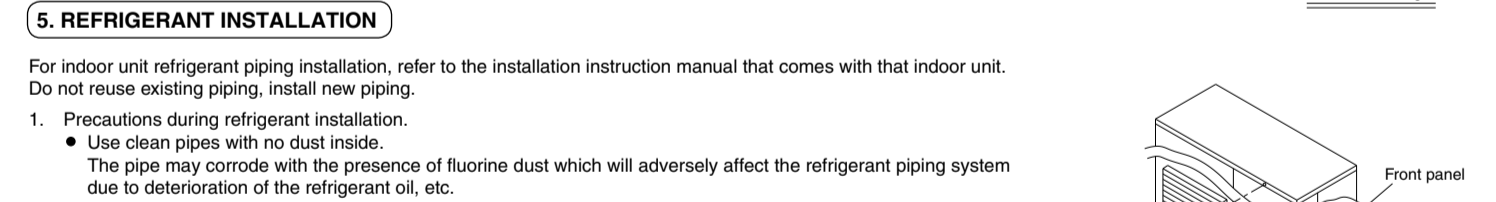

Precautions when operating the 3-way valve for piping installation.
1. Do not open the 3-way valve until the piping installation is completed.
2. Direction to pull out wires.

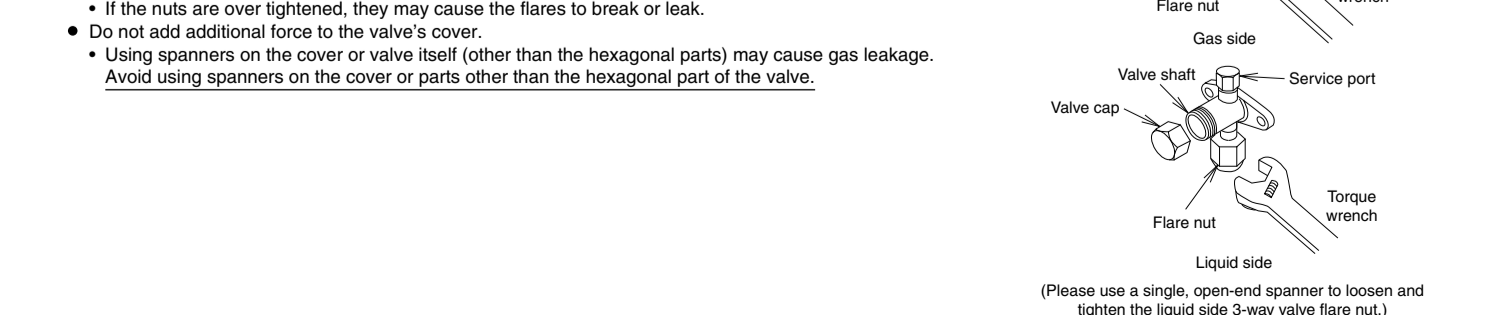

- Ensure to do the re-flaring of pipes before connecting to units to avoid leaking.
Insulation material and silicone sealant. Please ensure there are no gaps where moisture can enter the joint.

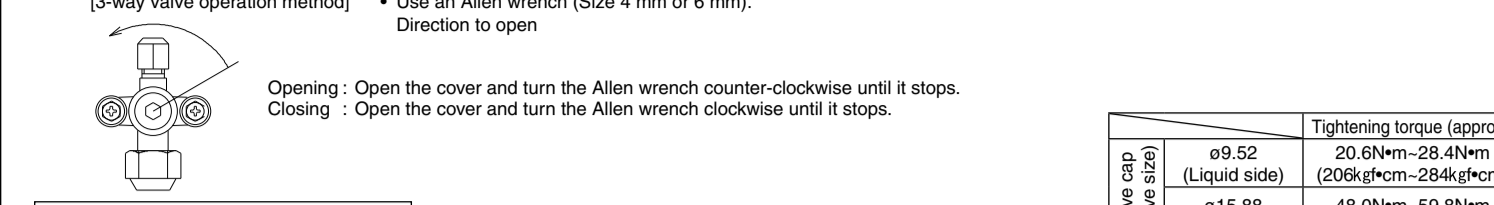

Precautions for handling the valve cap.
1. Ensure not to scratch the inner surface of the valve or the end of the valve shaft.
2. Once adjustments to the valves are completed, ensure to tighten the valve cap according to the prescribed torque.

Precautions for handling the service ports.
1. Use a push-rod with a charge hose.
2. Once adjustments to the valves are completed, ensure to tighten the valve cap according to the prescribed torque.

Precautions for connecting the pipes.
1. For proper connection, align the union and flare straight with each other.
2. Ensure that the pipes do not come into contact with the compressor's bolts or exterior panel.

Precautions for insulation installation.
1. In high humidity environment, reinforce the insulation material for the refrigerant piping. Failure to do so may result in condensation on the surface of the insulation material.

Precautions for flare nut installation.
1. Dimensions when adding flare nuts and the tightening torque.
2. For the flare nuts at piping connections, be sure to use the flare nuts that were supplied with the unit.

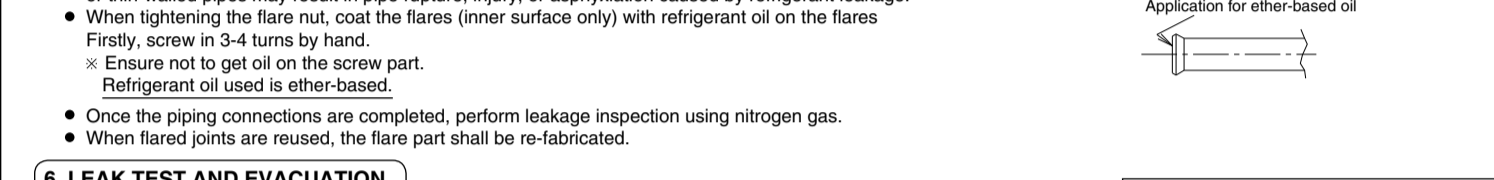

6. LEAK TEST AND EVACUATION.
Leak Tightness Test Method.
1. Keep 3-way valve fully closed and pressure through three-way valve service port.
2. Do not pressurize to the default value at once. Pressurize gradually.

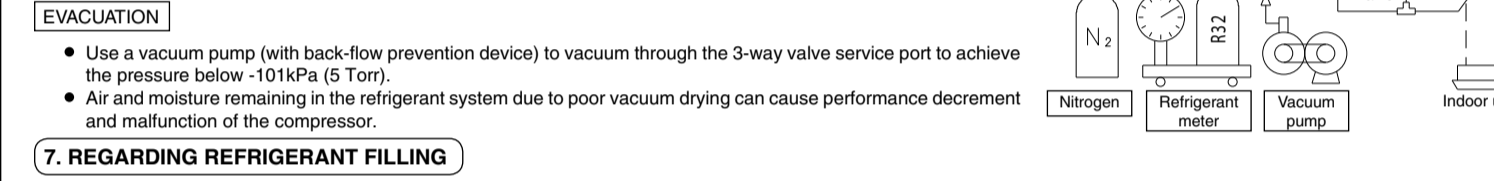

7. REGARDING REFRIGERANT FILLING.
Precautions during refrigerant filling.
1. Ensure to fill only liquid refrigerant when refilling.
2. If gas refrigerant is filled, the refrigerant composition will not be balanced and will cause abnormal operation.

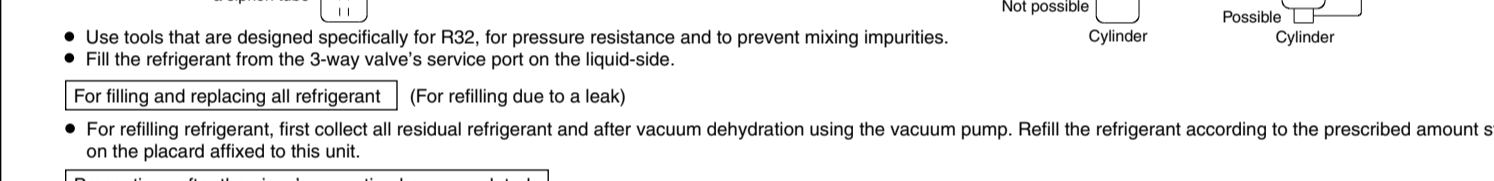

8. ELECTRICAL WIRING.
This air conditioner must be installed in accordance with national wiring regulations.
Cables connected to outdoor unit must be approved polychloroprene sheathed type 60245 IEC 57 or HD95RN7407RN F or heavier.

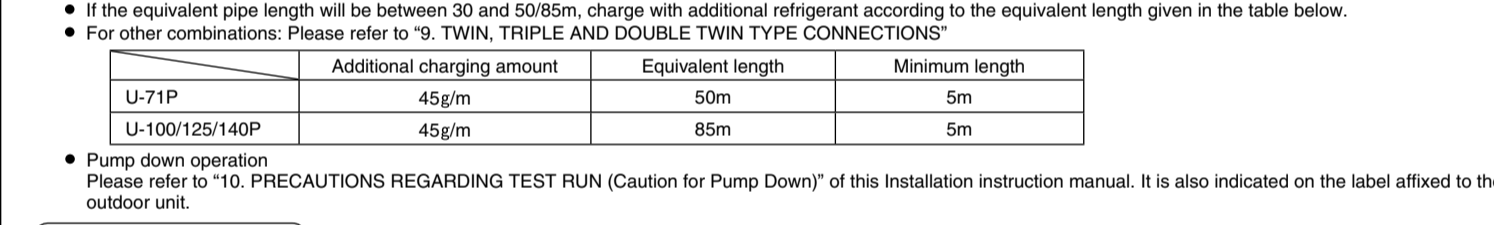

Precautions for handling the valve cap.
1. Ensure not to scratch the inner surface of the valve or the end of the valve shaft.
2. Once adjustments to the valves are completed, ensure to tighten the valve cap according to the prescribed torque.

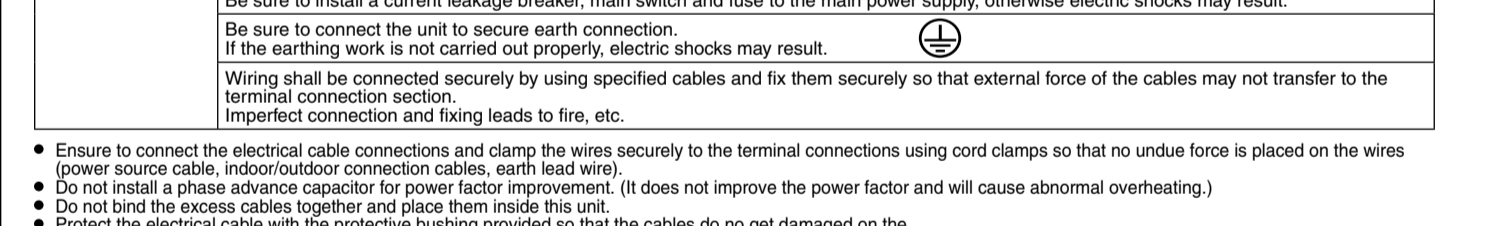

Precautions when operating the 3-way valve for piping installation.
1. Do not open the 3-way valve until the piping installation is completed.
2. Direction to pull out wires.

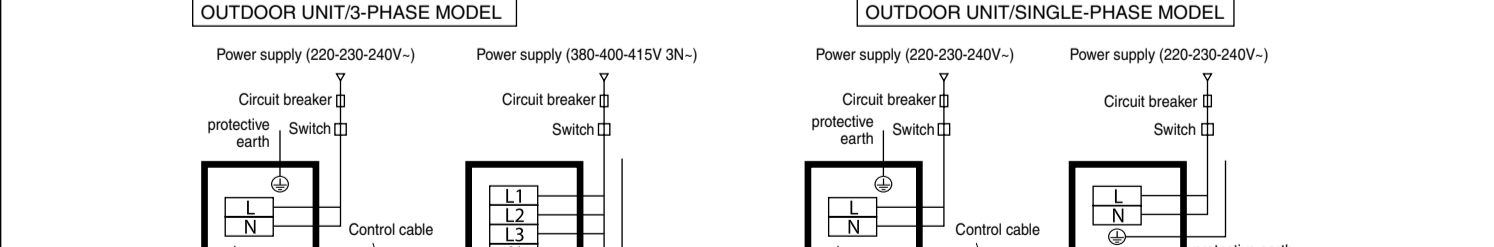
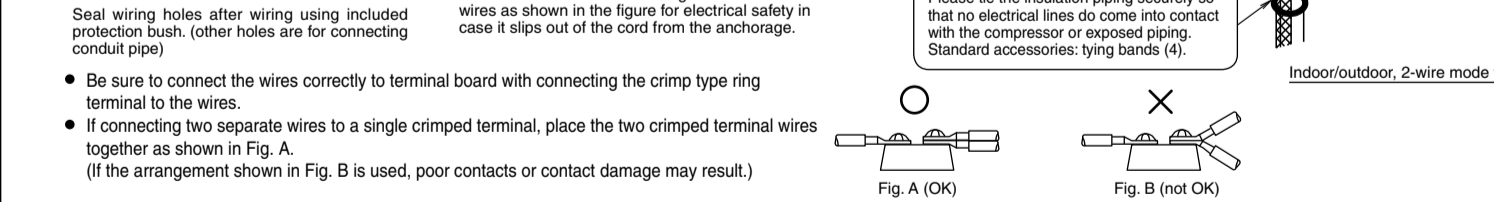
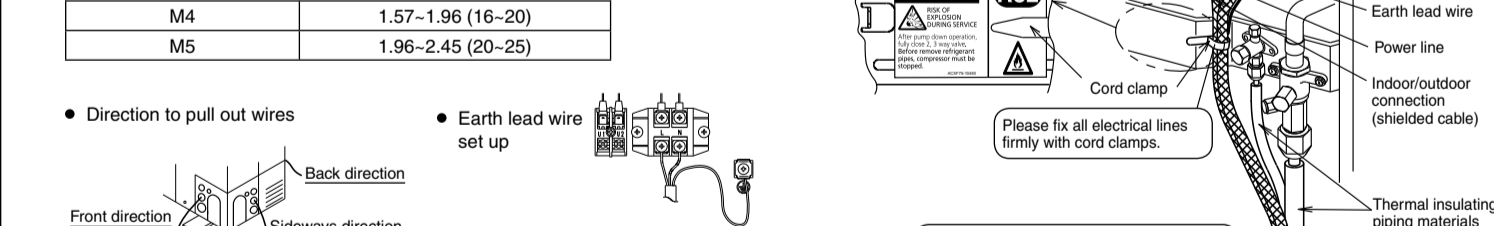

Precautions when operating the 3-way valve for piping installation.
1. Do not open the 3-way valve until the piping installation is completed.
2. Direction to pull out wires.

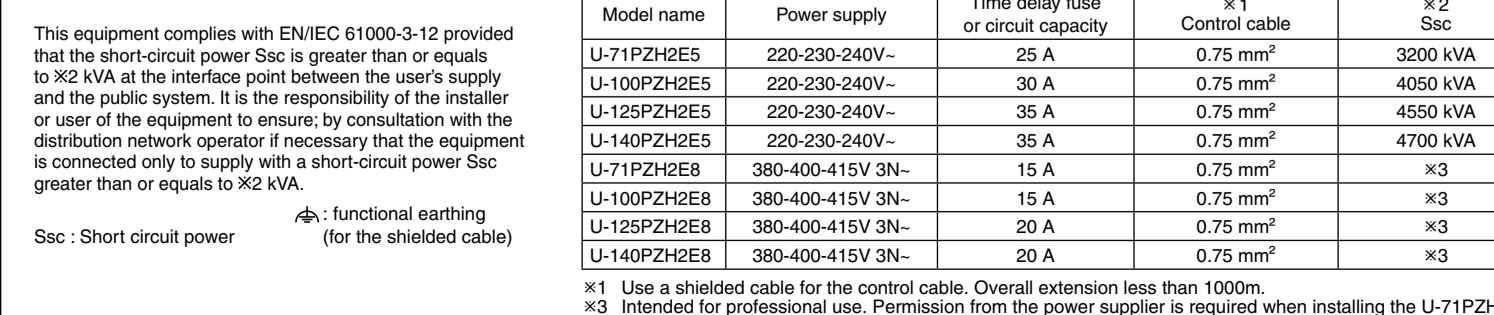

- The product meets the technical requirements of EN12531-3.
Decide the length and size of the power supply cable in accordance with the national wiring regulations.
Select the fuse(s) and/or circuit breaker(s) from the types and ratings suitable for the maximum ampere tabulated above in accordance with the national wiring regulations.

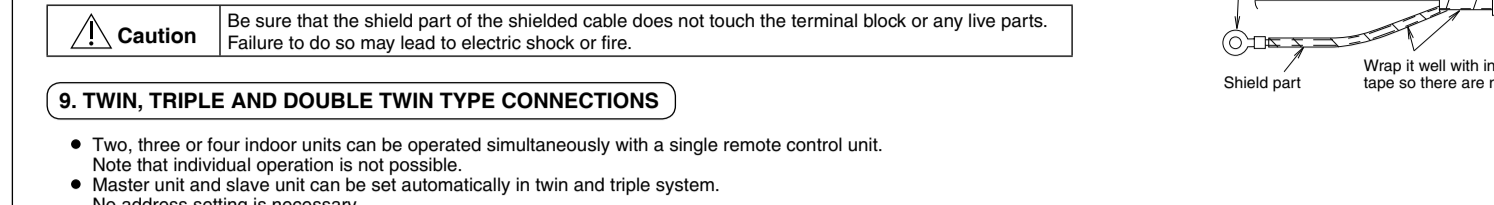

9. TWIN, TRIPLE AND DOUBLE TWIN TYPE CONNECTIONS.
Two, three or four indoor units can be operated simultaneously with a single remote control unit.
Note: Individual operation is not possible.

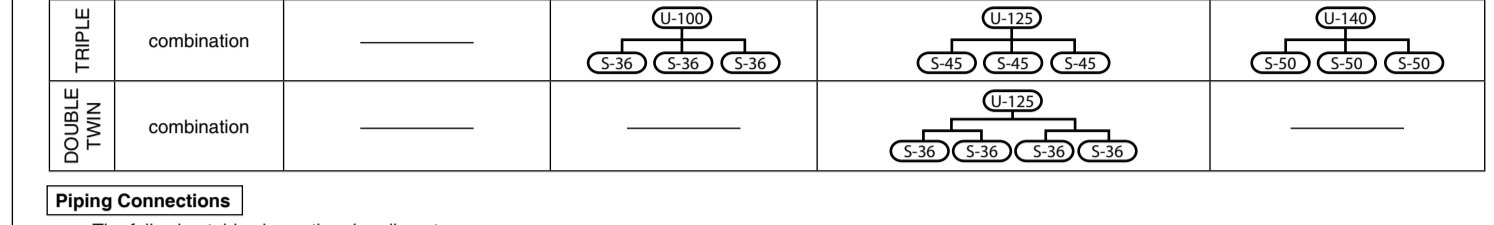

Piping Connections table. Lists branch pipe diameter, liquid side, gas side, and branch pipe kit should be used.

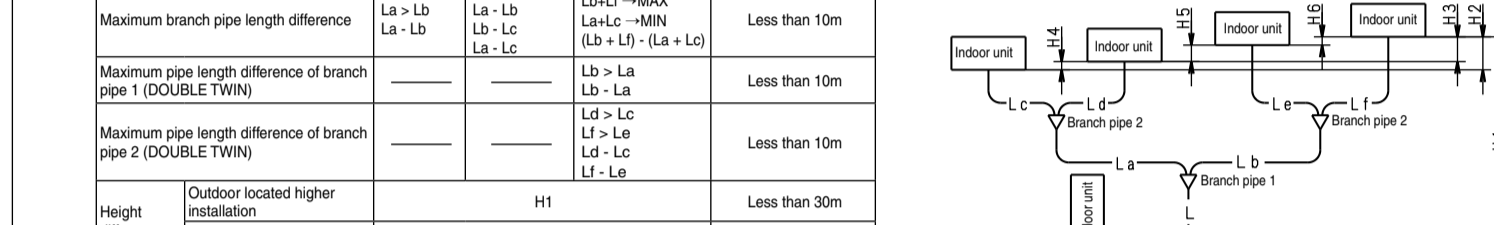
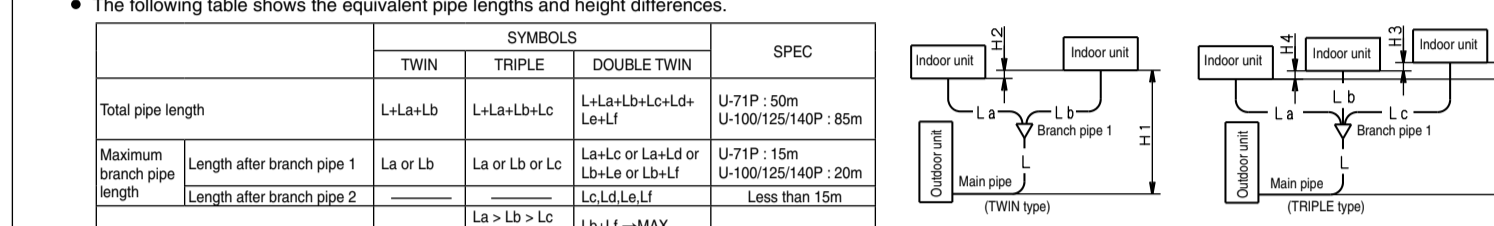

Refrigerant charging.
For the twin connection, the amount of refrigerant required for pipe length 30m has been included in this unit at the factory while that required for pipe length 20m has been included for the triple/double-twin connections.

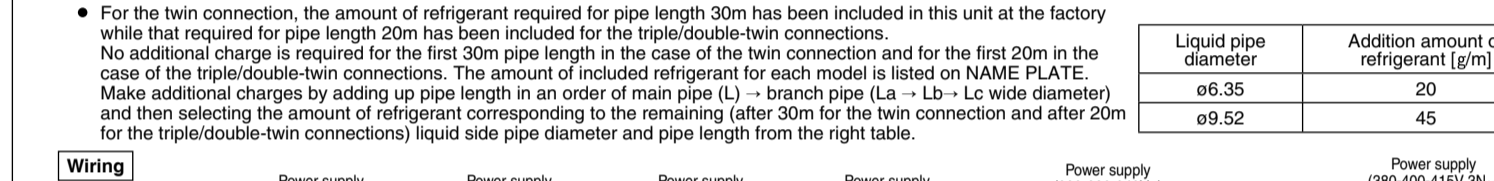

10. PRECAUTIONS REGARDING TEST RUN.
Check Before Test Run.
Power supply cable/indoor/outdoor connection wire/Earth wire.

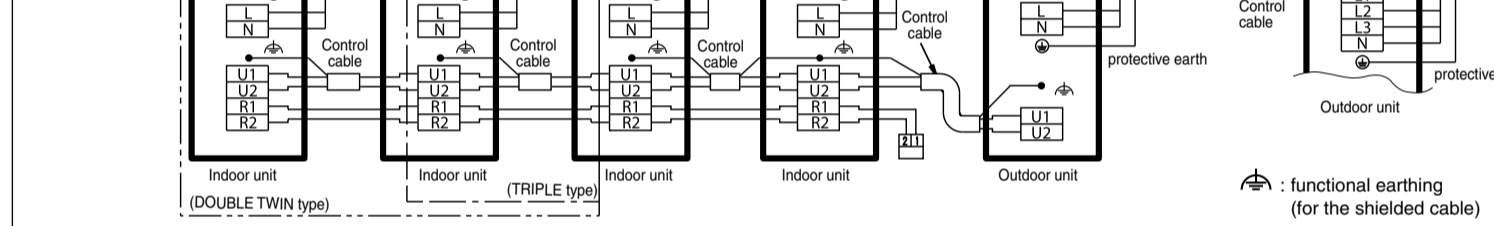

Test Run Precautions.
If there are duplicated system addresses, or if the settings for the Nos. of the indoor units are not consistent, an alarm will occur and the system will not start.

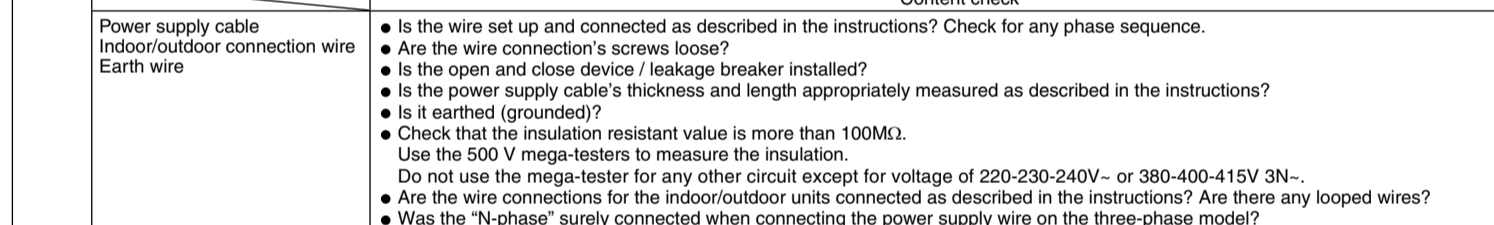

Caution for Pump Down.
Pump-down means refrigerant gas in the system is returned to the outdoor unit. Pump-down is used when the unit is to be moved, or before servicing the refrigerant circuit.

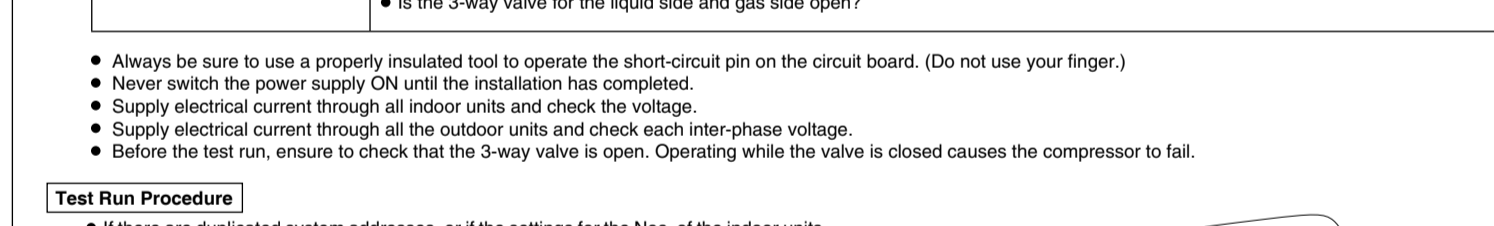

How to perform Pump-Down (Refrigerant recovery) properly.
1. Stop operation of the unit (cooling, heating etc.).
2. Connect the pressure gauge to the service port of the gas wiring valve.

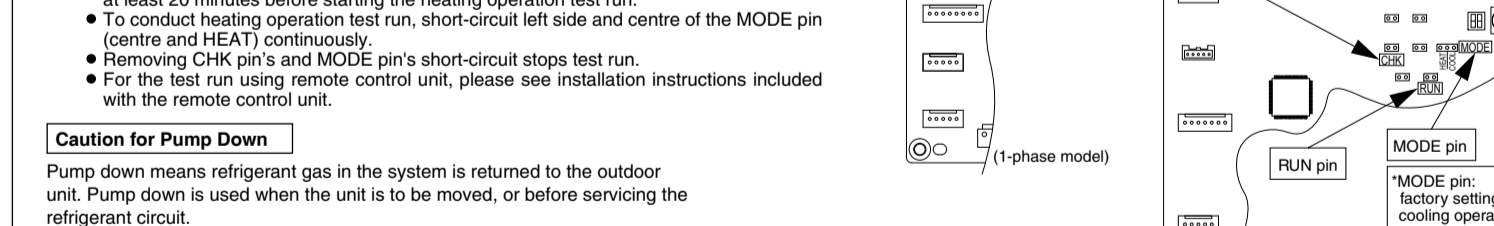

11. CHECKS AFTER INSTALLATION HAVE COMPLETED.
Check the following items after completing installation.
1. Is there a short circuit with the intake air flow?
2. Is the insulation secure? (Refrigerant piping)

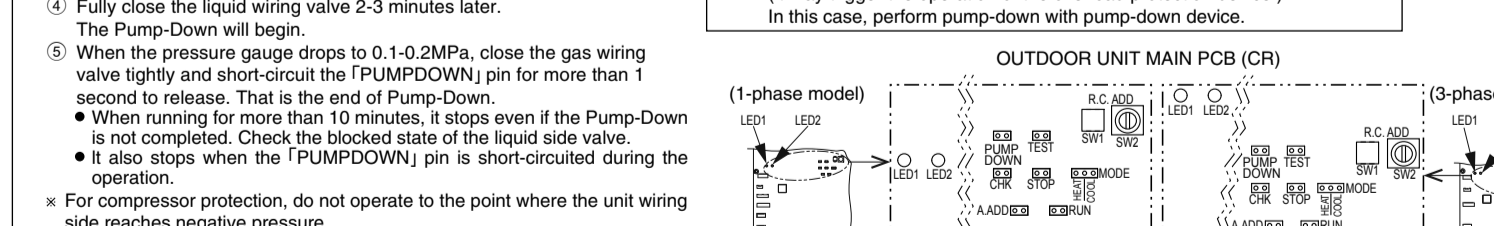

12. REGARDING DELIVERY TO THE CUSTOMER.
Request the customer to review the operating instructions and explain the operating method for the product.
In addition, it is also recommended that regular inspection checks are agreed upon for maintenance.

